



Microprocessor Controlled
IGBT Drive
Inverter Motor Speed Regulator
Operating Manual

L510 Series	100V	0.2~0.75kW (0.25~1HP)
	200V	0.2~2.2kW (0.25~3HP)
	400V	0.75~2.2kW (1~3HP)



Information
provided by

EMAG

Tel: 01902 601403

www.emag-ltd.co.uk

TECO 

TECO Europe

Rivium 3e straat 17, 2909 LH Capelle a/d IJssel, The Netherlands

Tel: +31 (0) 10 266 6633

Fax: +31 (0) 10 202 6415

<http://www.teco-group.eu/>

Distributor

Ver: 03EU-b 2014.7

This manual may be modified when necessary because of improvement of the product, modification, or change in specifications. This manual is subject to change without notice.

L510

Table of Contents

Chapter 0	Preface	0-1
	0.1 Preface	0-1
Chapter 1	Safety Precautions	1-1
	1.1 Before Power UP	1-1
	1.2 During Power UP	1-2
	1.3 Before Operation	1-2
	1.4 During Operation	1-3
	1.5 Inverter Disposal	1-3
Chapter 2	Part Number Definition	2-1
	2.1 Model part number	2-1
	2.2 Standard Product Specification	2-2
Chapter 3	Environment & Installation	3-1
	3.1 Environment	3-1
	3.2 Installation	3-2
	3.2.1 Installation methods	3-2
	3.2.2 Installation space	3-4
	3.2.3 De-rating curve	3-5
	3.3 Wiring guidelines	3-6
	3.3.1 Power cables	3-6
	3.3.2 Control cable selection and wiring	3-7
	3.3.3 Wiring and EMC guidelines	3-8
	3.3.4 Failure liability	3-9
	3.3.5 Considerations for peripheral equipment	3-10
	3.3.6 Ground connection	3-11
	3.3.7 Inverter exterior	3-11
	3.4 Specifications	3-12
	3.4.1 Product Specifications	3-12
	3.4.2 General Specifications	3-13
	3.5 Standard wiring	3-15
	3.5.1 Single phase(NPN input)	3-15
	3.5.2 Single phase(PNP input)	3-16
	3.5.3 Three phase(NPN input)	3-17
	3.5.4 Three phase(PNP input)	3-18
	3.6 Terminal Description	3-19
	3.6.1 Description of main circuit terminals	3-19
	3.6.2 Control circuit terminal description	3-20
	3.7 Outline Dimensions	3-21
	3.8 EMC filter Disconnection	3-23
Chapter 4	Software Index	4-1
	4.1 Keypad Description	4-1
	4.1.1 Operator Panel Functions	4-1
	4.1.2 Digital Display Description	4-2
	4.1.3 Digital Display Setup	4-4

	4.1.4 Example of Keypad Operation	4-6
	4.1.5 Operation Control	4-8
	4.2 Programmable Parameter Groups	4-9
	4.3 Parameter Function Description	4-22
Chapter 5	Troubleshooting and Maintenance	5-1
	5.1 Error Display and Corrective Action	5-1
	5.1.1 Manual Reset and Auto-Reset	5-1
	5.1.2 Keypad Operation Error Instruction	5-2
	5.1.3 Special conditions	5-3
	5.2 General troubleshooting	5-4
	5.3 Troubleshooting of the inverter	5-5
	5.4 Routine and periodic inspection	5-5
	5.5 Maintenance	5-6
Chapter 6	Peripheral Components	6-1
	6.1 Reactor Specifications	6-1
	6.2 Electromagnetic Contactor and No fuse circuit breaker	6-1
	6.3 Fuse Specification	6-1
	6.4 Fuse Specification(UL Model Recommended)	6-1
	6.5 Barking Resistor	6-2
Appendix 1	L510 Parameters Setting List	App1-1
Appendix 2	L510 MODBUS Communication protocol	App2-1
Appendix 3	JN5-CM-USB instruction manual	App3-1
Appendix 4	Instructions for UL	App4-1
Appendix 5	510 series accessories manual	App5-1

Chapter 0 Preface

0.1 Preface

To extend the performance of the product and ensure personnel safety, please read this manual thoroughly before using the inverter. Should there be any problem in using the product that cannot be solved with the information provided in the manual, contact our technical or sales representative who will be willing to help you.

※Precautions

The inverter is an electrical product. For your safety, there are symbols such as “Danger”, “Caution” in this manual as a reminder to pay attention to safety instructions on handling, installing, operating, and checking the inverter. Be sure to follow the instructions for highest safety.



Danger

Indicates a potential hazard that could cause death or serious personal injury if misused.



Caution

Indicates that the inverter or the mechanical system might be damaged if misused.

⚠ Danger

- Risk of electric shock. The DC link capacitors remain charged for five minutes after power has been removed. It is not permissible to open the equipment until 5 minutes after the power has been removed.
- Do not make any connections when the inverter is powered on. Do not check parts and signals on circuit boards during the inverter operation.
- Do not disassemble the inverter or modify any internal wires, circuits, or parts.
- Ensure that the Inverter Ground terminal is connected correctly.

⚠ Caution

- Do not perform a voltage test on parts inside the inverter. High voltage can destroy the semiconductor components.
- Do not connect T1, T2, and T3 terminals of the inverter to any AC input power supply.
- CMOS ICs on the inverter's main board are susceptible to static electricity. Do not touch the main circuit board.

Chapter 1 Safety Precautions

1.1 Before Power Up

Danger

- Make sure the main circuit connections are correct. Single phase L1(L),L3(N), and Three phase L1(L),L2,L3(N); 400V : L1,L2,L3 are power-input terminals and must not be mistaken for T1,T2 and T3. Otherwise, inverter damage can result.

Caution

- The line voltage applied must comply with the inverter's specified input voltage.(See the nameplate)
- To avoid the front cover from disengaging, or other damage do not carry the inverter by its covers. Support the drive by the heat sink when transporting. Improper handling can damage the inverter or injure personnel and should be avoided.
- To avoid the risk of fire, do not install the inverter on a flammable object.Install on nonflammable objects such as metal.
- If several inverters are placed in the same control panel, provide heat removal means to maintain the temperature below 50 degree C to avoid overheat or fire.
- When disconnecting the remote keypad, turn the power off first to avoid any damage to the keypad or the inverter.

Warning

- This product is sold subject to EN 61800-3 and EN 61800-5-1. In a domestic environment this product may cause radio interference in which case the user may be required to apply corrective measures.
- Motor over temperature protection is not provided.

Caution

- Work on the device/system by unqualified personnel or failure to comply with warnings can result in severe personal injury or serious damage to material. Only suitably qualified personnel trained in the setup, installation, commissioning and operation of the product should carry out work on the device/system.
- Only permanently-wired input power connections are allowed.

1.2 During Power Up

Danger

- When the momentary power loss is longer than 2 seconds, the inverter will not have sufficient stored power for its control circuit. Therefore, when the power is re-applied, the run operation of the inverter will be based on the setup of following parameters:
 - Run parameters. 00-02 or 00-03.
 - Direct run on power up. Parameter. 07-04 and the status of external run switch,

Note-: the start operation will be regardless of the settings for parameters 07-00/07-01/07-02.

Danger. Direct run on power up.

If direct run on power up is enabled and inverter is set to external run with the run FWD/REV switch closed then the inverter will restart.

Danger

Prior to use, ensure that all risks and safety implications are considered.

- When the momentary power loss ride through is selected and the power loss is short, the inverter will have sufficient stored power for its control circuits to function, therefore, when the power is resumed the inverter will automatically restart depending on the setup of parameters 07-00 & 07-01.

1.3 Before Operation

Caution

- Make sure the model and inverter capacity are the same as that set in parameter 13-00.

Note : On power up the supply voltage set in parameter 01-01 will flash on display for 2 seconds.

1.4 During Operation

Danger

- Do not connect or disconnect the motor during operation. Otherwise, It may cause the inverter to trip or damage the unit.

Danger

- To avoid electric shock, do not take the front cover off while power is on.
- The motor will restart automatically after stop when auto-restart function is enabled. In this case, care must be taken while working around the drive and associated equipment .
- The operation of the stop switch is different than that of the emergency stop switch. The stop switch has to be activated to be effective. Emergency stop has to be de-activated to become effective.

Caution

- Do not touch heat radiating components such as heat sinks and brake resistors.
- The inverter can drive the motor from low speed to high speed. Verify the allowable speed ranges of the motor and the associated machinery.
- Note the settings related to the braking unit.
- Risk of electric shock. The DC link capacitors remain charged for five minutes after power has been removed. It is not permissible to open the equipment until 5 minutes after the power has been removed.

Caution

- The Inverter should be used in environments with temperature range from (14-104°F) or (-10 to 40°C) and relative humidity of 95%.

Note: models with fan : -10~50°C , models without fan : -10~40°C

Danger

- Make sure that the power is switched off before disassembling or checking any components.

1.5 Inverter Disposal

Caution

Please dispose of this unit with care as an industrial waste and according to your required local regulations.

- The capacitors of inverter main circuit and printed circuit board are considered as hazardous waste and must not be burnt.
- The Plastic enclosure and parts of the inverter such as the cover board will release harmful gases if burnt.

Chapter 2 Part Number Definition

2.1 Model part number

L510 - 1P2 - H1 - N

Supply voltage
1 : 100V Class
2 : 200V Class
4 : 400V Class

Internal Voltage
Blank : +12V Series
A : +24V Series

Horsepower
100V Class P2: 0.25 HP 400V Class 01: 1HP
P5: 0.5 HP 02: 2HP
01: 0.75 HP 03: 3HP
200V Class P2: 0.25 HP
P5: 0.5 HP
01: 1 HP
02: 2 HP
03: 3 HP

P : PNP
N : NPN

Filter
F : Built-in
Blank : None

Power supply
1 : Single phase
3 : Three phase

Specification
H : Standard Type

Information
provided by
EMAG
Tel: 01902 601403
www.emag-ltd.co.uk

2.2 Standard Product Specification

100V/200V (If the model is marked A, it means that it is built in the power supply of 24V; if not, then it is built in the power supply of 12V.)

400V (Models of 400V machines are all marked A, built in the power supply of 24V.)

Model	Supply Voltage (Vac)	Frequency (Hz)	(HP)	(KW)	Model		Filter	
					NPN	PNP	Built-in	None
L510-1P2-H1-N(A)	1ph, 100~120V +10%/-15%	50/60Hz	0.25	0.2	⊙			⊙
L510-1P5-H1-N(A)			0.5	0.4	⊙			⊙
L510-101-H1-N(A)			1	0.75	⊙			⊙
L510-2P2-H1F-P(A)	1ph, 200~240V +10%/-15%		0.25	0.2		⊙	⊙	
L510-2P5-H1F-P(A)			0.5	0.4		⊙	⊙	
L510-201-H1F-P(A)			1	0.75		⊙	⊙	
L510-202-H1F-P(A)			2	1.5		⊙	⊙	
L510-203-H1F-P(A)			3	2.2		⊙	⊙	
L510-2P2-H1-N(A)			0.25	0.2	⊙			⊙
L510-2P5-H1-N(A)			0.5	0.4	⊙			⊙
L510-201-H1-N(A)			1	0.75	⊙			⊙
L510-202-H1-N(A)			2	1.5	⊙			⊙
L510-203-H1-N(A)	3		2.2	⊙			⊙	
L510-2P2-H3-N(A)	3ph, 200~240V +10%/-15%		0.25	0.2	⊙			⊙
L510-2P5-H3-N(A)			0.5	0.4	⊙			⊙
L510-201-H3-N(A)		1	0.75	⊙			⊙	
L510-202-H3-N(A)		2	1.5	⊙			⊙	
L510-203-H3-N(A)		3	2.2	⊙			⊙	
L510-401-H3-N A		1	0.75	⊙			⊙	
L510-402-H3-N A	3ph, 380~480V +10%/-15%	50/60Hz	2	1.5	⊙			⊙
L510-403-H3-N A			3	2.2	⊙			⊙
L510-401-H3F-P A			1	0.75		⊙	⊙	
L510-402-H3F-P A			2	1.5		⊙	⊙	
L510-403-H3F-P A			3	2.2		⊙	⊙	

Suitable for use on a circuit capable of delivering not more than 5,000 rms symmetrical amperes, 120/240 volts maximum. The voltage shall be 120 for 100-120 V, 240 for 200-240 V, 480 for 380-480V rated units.

Chapter 3 Environment & Installation

3.1 Environment

Installation environment has a direct affect on the correct operation and the life expectancy of the inverter, Install the inverter in an environment complying with the following conditions:

Protection	
Protection class	IP20, NEMA/UL Open Type
Suitable environment	
Operating temperature	-10~40°C (-10~50°C with fan) If several inverters are installed in the same control panel, ensure adequate spacing and provide the necessary cooling and ventilation for successful operation.
Storage temperature	-20~60°C
Relative Humidity	Max 95% (without condensation) Notice prevention of inverter freezing up.
Shock	1G. (9.8m/s ²) for 20Hz and below. 0.6G (5.88m/s ²) from 20Hz to 50Hz

Installation site

Install in an environment that will not have an adverse effect on the operation of the unit and ensure that there is no exposure to areas such as that listed below:-

- Direct sunlight, Rain or moisture
- Oil mist and salt
- Dust, lint fibbers, small metal filings and corrosive liquid and gas
- Electromagnetic interference from sources such as welding equipment
- Radioactive and flammable materials
- Excessive vibration from machines such as stamping, punching machines
- Add a vibration-proof pads if necessary

Tightening torque for terminals

Chart 3-1

Model	TM1					TM2				
	Cable Size		Tightening torque			Cable Size		Tightening torque		
	AWG	mm ²	kgf.cm	lbf.in	Nm	AWG	mm ²	kgf.cm	lbf.in	Nm
Frame1	22~10	0.34~6	14	12.15	1.37	24~12	0.25~4	4.08	3.54	0.4
Frame2			12.24	10.62	1.2					

3.2 Installation

3.2.1 Installation methods

Frame1. Mounting on a flat surface.

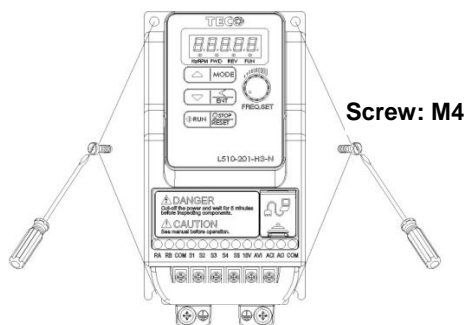

Din rail type installation:

Din rail kit includes a plastic and a metal adaptor plates.

Assembly Steps:-

- 1) Attach the metal adaptor plate to the inverter base with the screws provided.
- 2) Attach the plastic Din rail adaptor to the metal adaptor plate.
- 3) Push the plastic adaptor forward to lock into position.

Disassembly Steps:-

- 1) Unlock by pushing the snap hooks
- 2) Retract and remove the plastic Din rail adaptor.
- 3) Unscrew the metal plate & Remove

Assembly:-

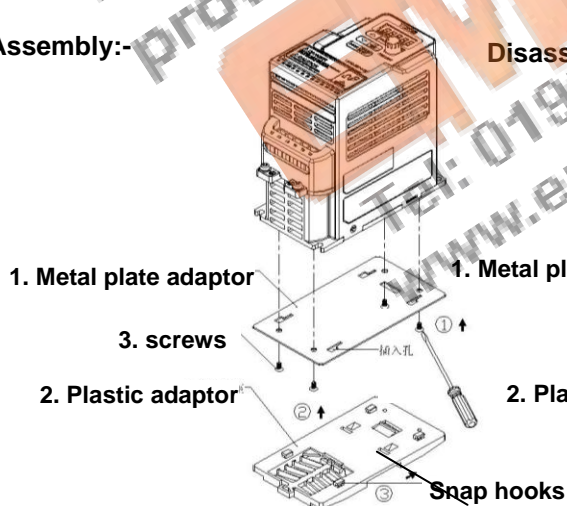

Disassembly:-

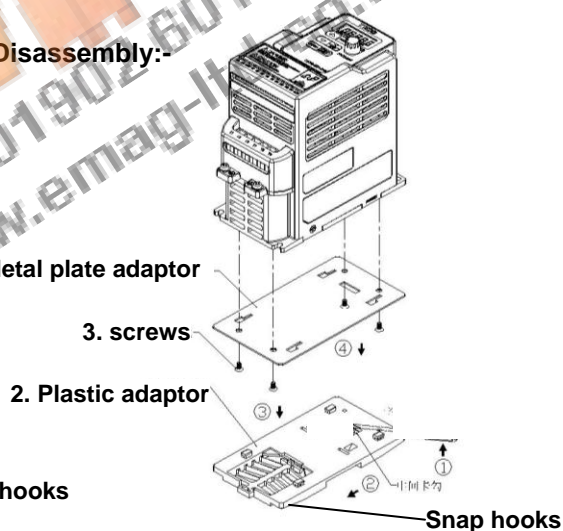

Note:

JN5-DIN-L01 (Frame 1 Din rail kit part number), including the following parts

1. Metal plate adaptor
2. Plastic adaptor
3. Chamfer head screw: M3x6

Frame 2. Mounting on a flat surface.

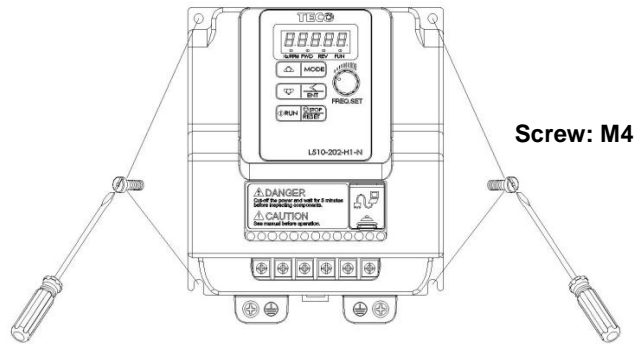

Din rail type installation:

Din rail kit includes a plastic adaptor plate as an attachment for the inverter base. Refer to Diagram below:-

Assembly:-

Disassembly:-

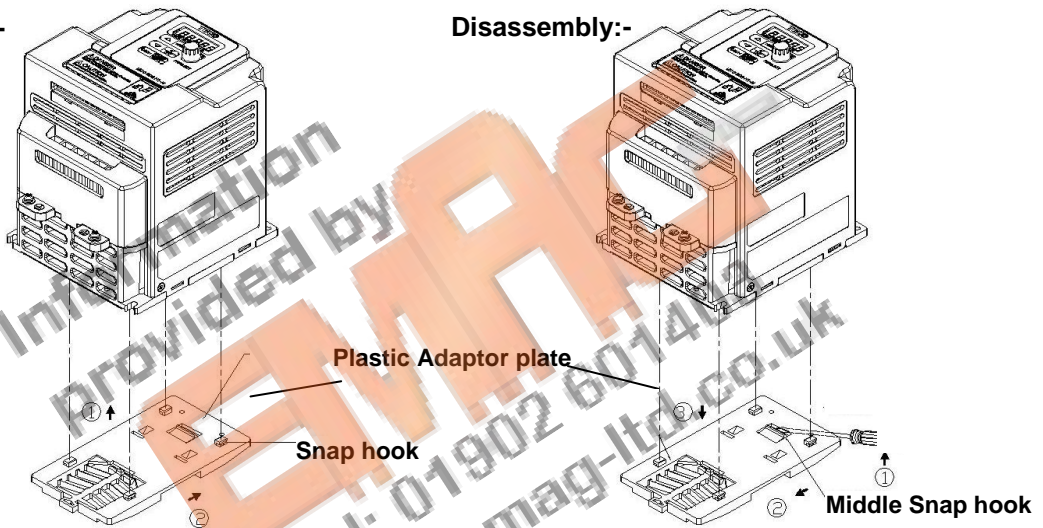

Din Rail Mounting & Dismounting as shown in the diagram below:-Use a 35mm Din Rail.

Mounting

Dismounting

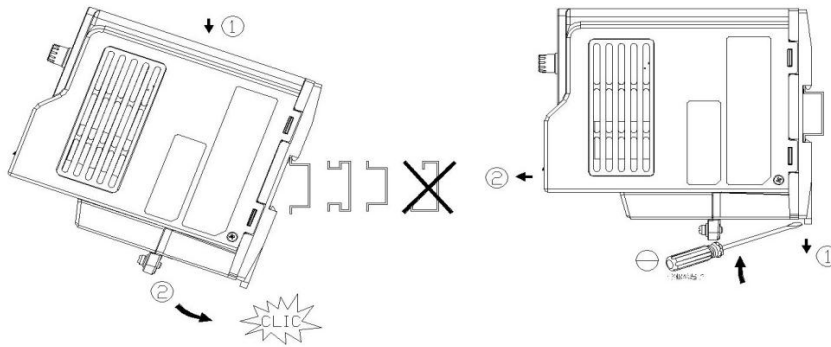

Plastic adaptor plate.
JNDINE2-201 (Frame 2 Din rail kit part number)

3.2.2 Installation space

Provide sufficient air circulation space for cooling as shown in examples below. Install the Inverter on surfaces that provide good heat dissipation.

Single unit Installation

Install the inverter vertically to obtain effective cooling.

Frames 1 & 2.

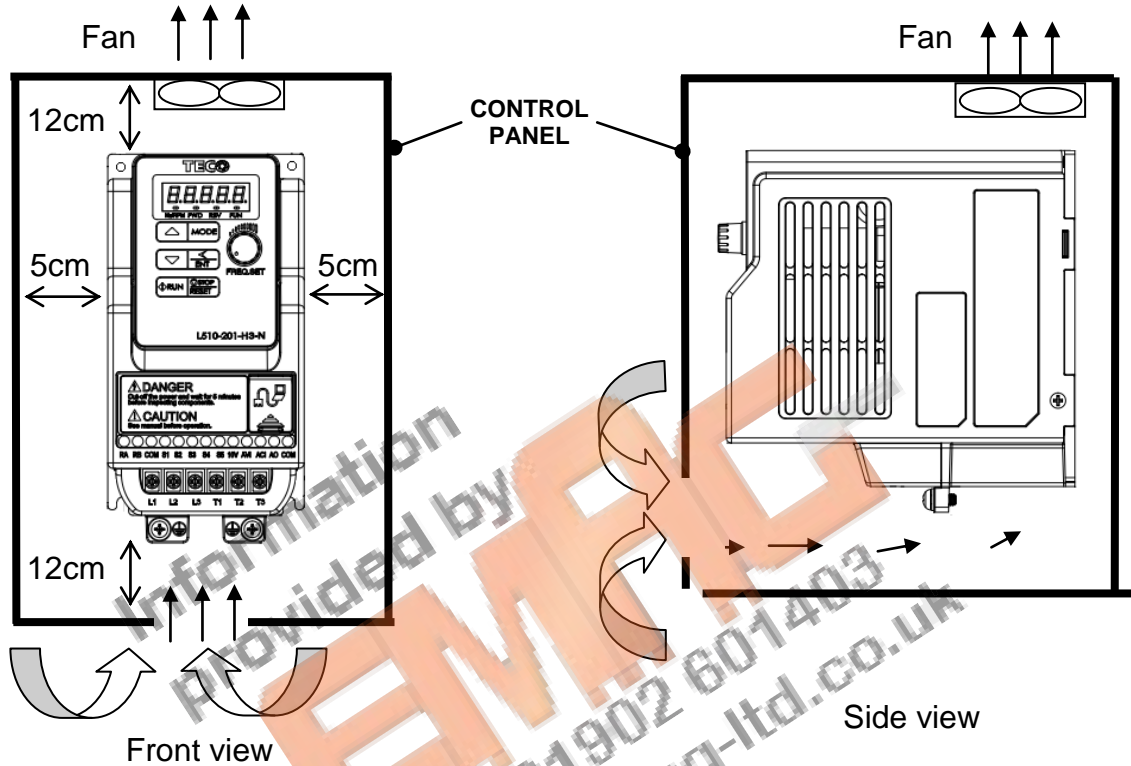

Side by side Installation

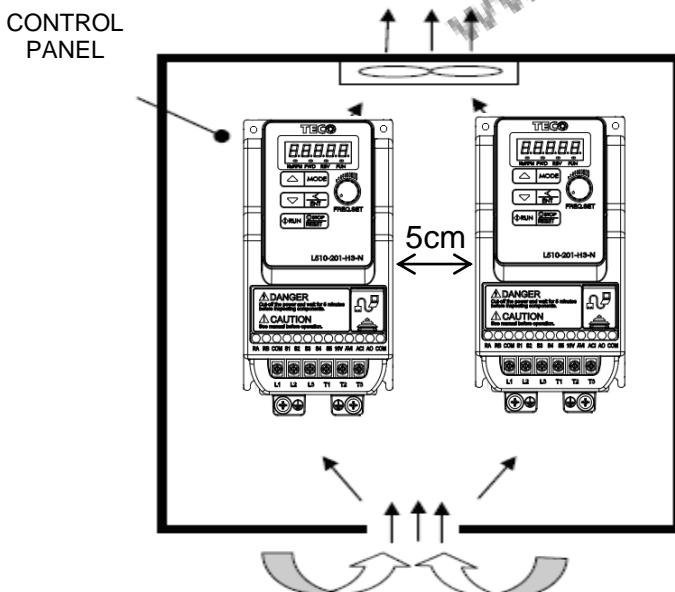

Provide the necessary physical space and cooling based on the ambient temperature and the heat loss in the panel

3.2.3 De-rating curve

Curves below show the applicable output current de-rate due to setting of carrier frequency and the ambient operating temperatures of 40 and 50 degree C. (For Frame1)

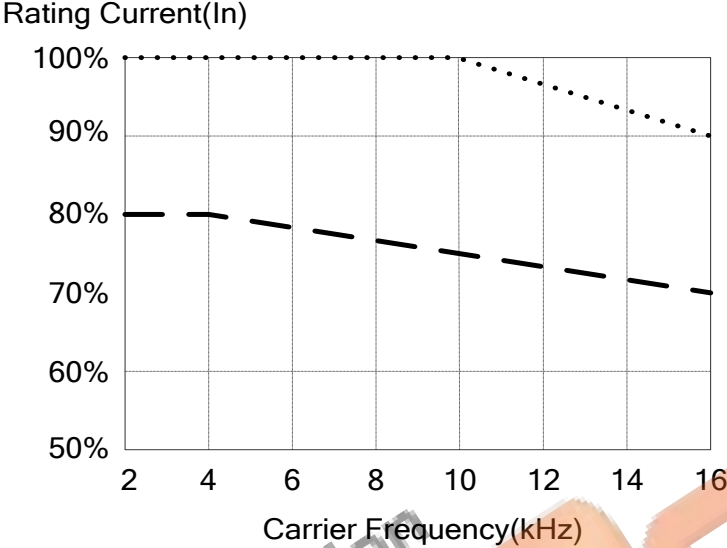

Note:

- De-rate curve of ambient temperature 40 degree C.
- - - - De-rate curve of ambient temperature 50 degree C.

Information provided by
EMAG
Tel: 01902 601403
www.emag-ltd.co.uk

3.3 Wiring Guidelines

3.3.1 Power Cables.

Supply power cable must be connected to TM1 terminal block, terminals L1(L) and L3(N) for single phase 200V supply, L1(L), L2, L3(N) for three phase 200V supply and L1, L2, L3 for three phase 400V supply.

Motor cable must be connected to TM1 terminals. T1, T2, T3.

Warning:- Connection of Supply line cable to terminals T1,T2& T3 will result in serious damage to the drive components.

Example power connections:- Inverter with dedicated power line.

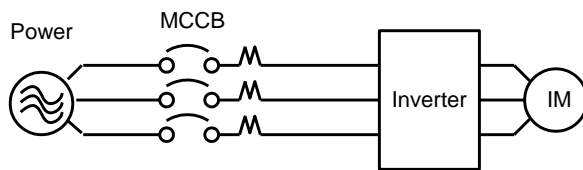

- Install a Supply RFI filter or Isolation transformer when the power source is shared with other high power electrical equipment as shown below.

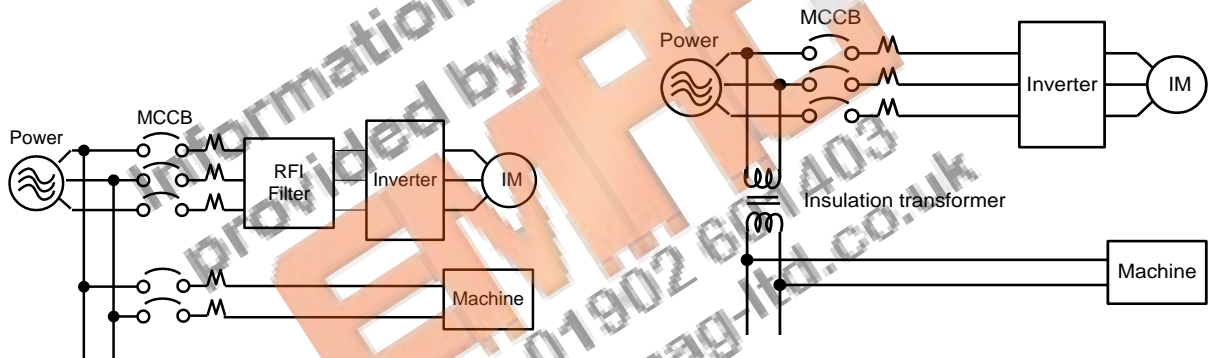

- The maximum rms symmetrical amperes and voltage are listed as follows:

Device Rating		Short circuit Rating	Maximum Voltage
voltage	HP		
110V	0.2~1	5000A	120V
220V	0.2~3	5000A	240V
440V	1~3	5000A	480V

- Electrical ratings of terminals:

Horsepower	Power Specification	Voltage (Volt)	Current(A)
0.25/0.5/1	220V	300	30
1	110V		20
2/3	220V		30
1/2/3	440V	600	28

3.3.2 Control Cable selection and Wiring.

Control cables should be connected to terminal block TM2.

Choose power & Control cables according to the following criteria:-

- Use copper wires with correct diameter and temperature rating of 60/75°C.
- Minimum cable voltage rating for 200V type inverters should be 300VAC.
- Route all cables away from other high voltage or high current power lines to reduce interference effects.

Use a twisted pair shielded cable and connect the shield (screen) wire to the ground terminal at the inverter end only. Cable length should not exceed 50 meters.

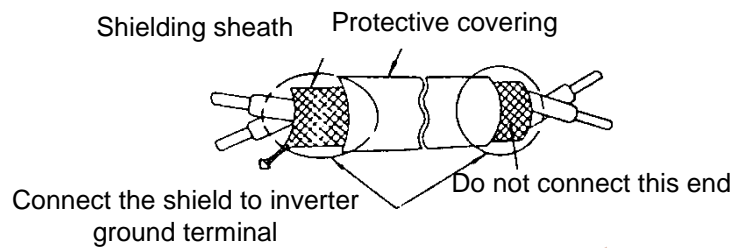

Information
provided by
EMAG
Tel: 01902 601403
www.emag-ltd.co.uk

3.3.3 Wiring and EMC guidelines.

For effective interference suppression, do not route power and control cables in the same conduit or trucking.

To prevent radiated noise, motor cable should be put in a metal conduit. Alternatively an armored or shielded type motor cable should be used.

For effective suppression of noise emissions the cable armor or shield must be grounded at both ends to the motor and the inverter ground. These connections should be as short as possible.

Motor cable and signal lines of other control equipment should be at the least 30 cm apart.

L510 has a built in Class “A” EMC filter to first Environment Restricted. (Category C2).

For some installations such as residential,(Category C1) an optional external Class “B” type filter will be necessary. Please consult your local supplier.

Typical Wiring.

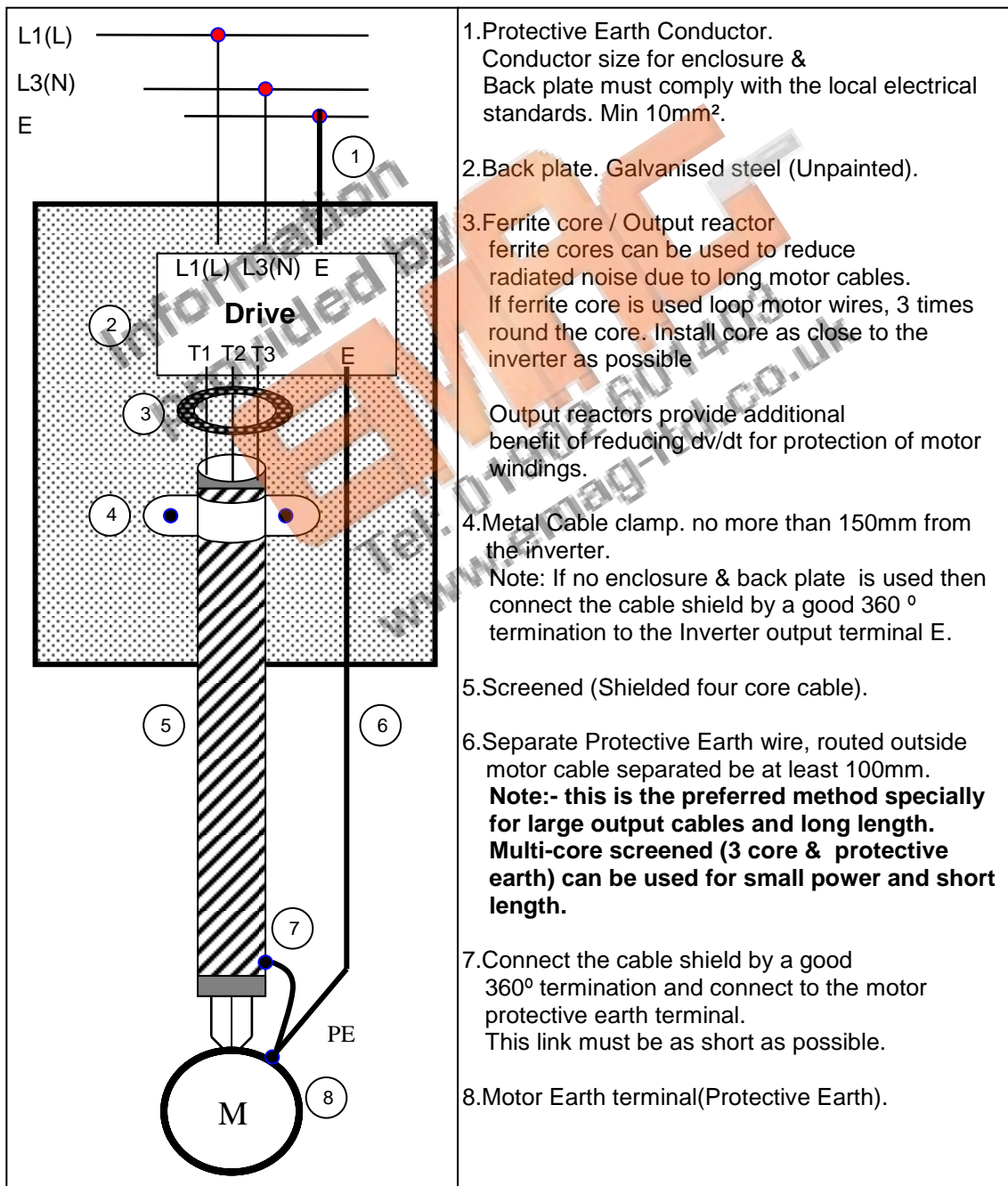

1. Protective Earth Conductor.
Conductor size for enclosure & Back plate must comply with the local electrical standards. Min 10mm².
2. Back plate. Galvanised steel (Unpainted).
3. Ferrite core / Output reactor
ferrite cores can be used to reduce radiated noise due to long motor cables. If ferrite core is used loop motor wires, 3 times round the core. Install core as close to the inverter as possible
Output reactors provide additional benefit of reducing dv/dt for protection of motor windings.
4. Metal Cable clamp. no more than 150mm from the inverter.
Note: If no enclosure & back plate is used then connect the cable shield by a good 360° termination to the Inverter output terminal E.
5. Screened (Shielded four core cable).
6. Separate Protective Earth wire, routed outside motor cable separated be at least 100mm.
Note:- this is the preferred method specially for large output cables and long length. Multi-core screened (3 core & protective earth) can be used for small power and short length.
7. Connect the cable shield by a good 360° termination and connect to the motor protective earth terminal.
This link must be as short as possible.
8. Motor Earth terminal(Protective Earth).

3.3.4 Failure liability

- Teco bears no responsibility for any failures or damaged caused to the inverter if the recommendations in this instruction manual have not been followed specifically points listed below,
- If a correctly rated Fuse or Circuit breaker has not been installed between the power source and the inverter.
- If a magnetic contactor, a phase capacitor, burst absorber and LC or RC circuits have been connected between the inverter and the motor.
- If an incorrectly rated three-phase squirrel cage induction motor has been used

Note:

When one inverter is driving several motors, the total current of all motors running simultaneously must be less than the rated current of the inverter, and each motor has to be equipped with a correctly rated thermal overload relay.

Information
provided by
EMAG
Tel: 01902 601403
www.emag-ltd.co.uk

3.3.5 Considerations for peripheral equipment

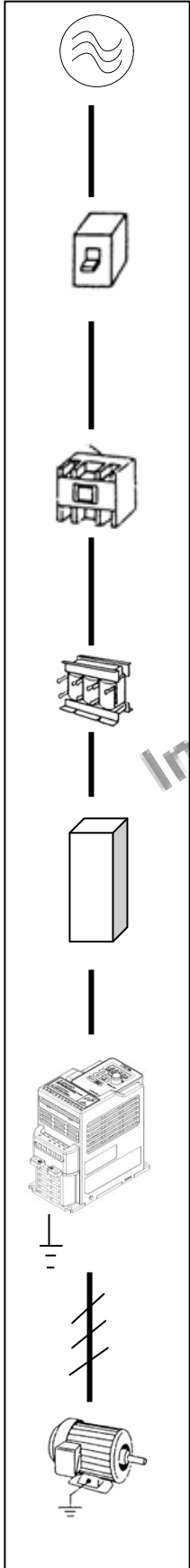
	<p>Power</p>	<p>Ensure that the supply voltage is correct. A molded-case circuit breaker or fused disconnect must be installed between the AC source and the inverter</p>
<p>Circuit Breaker & RCD</p>	<p>Use a molded-case circuit breaker that conforms to the rated voltage and current of the inverter. Do not use the circuit breaker as the run/stop switch for the inverter. Residual Current Circuit Breaker(RCD) Current setting should be 200mA or above and the operating time at 0.1 second or longer to prevent malfunctions.</p>	
<p>Magnetic contactor</p>	<p>Normally a magnetic contactor is not needed. A contactor can be used to perform functions such as external control and auto restart after power failure. Do not use the magnetic contactor as the run/stop switch for the inverter.</p>	
<p>AC reactor for power quality improvement</p>	<p>When a 200V/400V inverter with rating below 15KW is connected to a high capacity power source (600KVA or above) then an AC reactor can be connected for power factor improvement and reducing harmonics.</p>	
<p>Input noise filter</p>	<p>L510 inverter has a built-in filter to Class "A" first Environment. (CategoryC2) To satisfy the required EMC regulations for your specific application you may require an additional EMC filter.</p>	
<p>Inverter</p>	<p>Connect the single phase power to Terminals, L1(L) & L3(N) and three phase power to Terminals : (200V : L1(L),L2,L3(N) or 400V : L1,L2,L3) Warning! Connecting the input terminals T1, T2, and T3 to AC input power will damage the inverter. Output terminals T1, T2, and T3 are connected to U, V, and W terminals of the motor. To reverse the motor rotation direction just swap any two wires at terminals T1, T2, and T3. Ground the Inverter and motor correctly. Ground Resistance for 200V power<100 Ohms.</p>	
<p>Motor</p>	<p>Three-phase induction motor. Voltage drop on motor due to long cable can be calculated. Volts drop should be < 10%. Phase-to-phase voltage drop (V) = $\sqrt{3} \times \text{resistance of wire } (\Omega/\text{km}) \times \text{length of line (m)} \times \text{current} \times 10^{-3}$</p>	

3.3.6 Ground connection

Inverter Ground terminal must be connected to installation ground correctly and according to the required local wiring regulations.

- Ground cable size must be according to the required local wiring regulations. Ground connection should be as short as possible.
- Do not share the ground of the inverter with other high current loads (Welding machine, high power motors). Ground each unit separately.
- Ensure that all ground terminals and connections are secure
- Do not make ground loops when several inverters share a common ground point.

Note: Please leave at least 5cm while installing inverter side by side in order to provide enough cooling space.

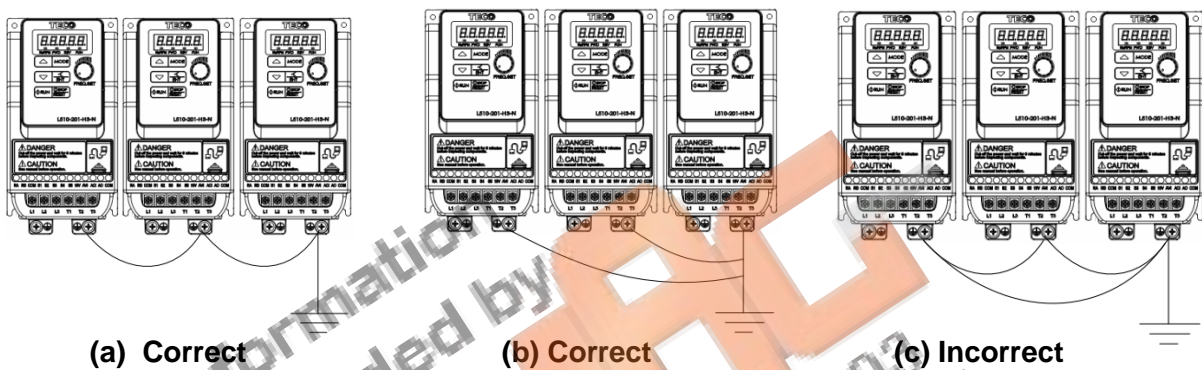

3.3.7 Inverter exterior

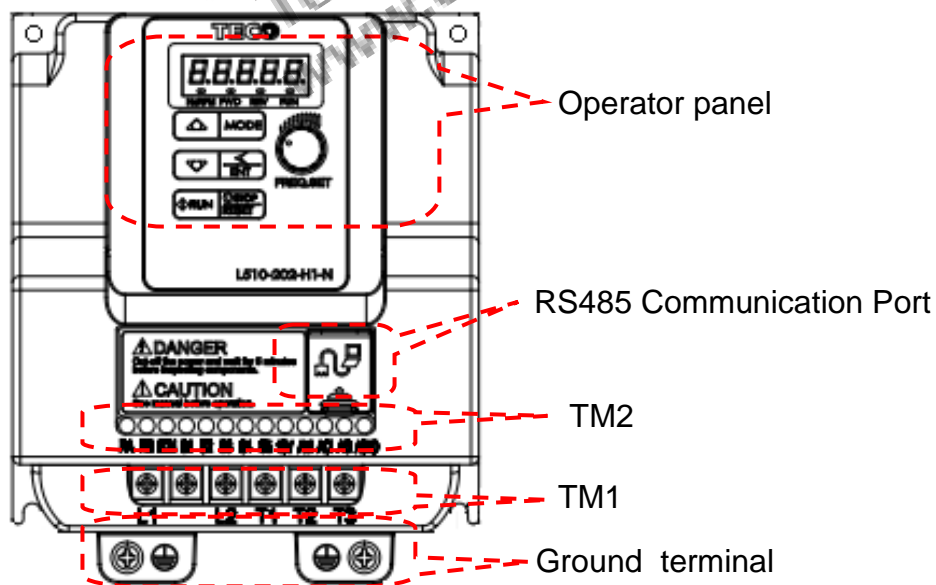

3.4 Specifications

3.4.1 Product Specifications

100V Class : Single phase

Model : L510-□□□-H1-N (A)	1P2	1P5	101
Horse power (HP)	0.25	0.5	1
Suitable motor capacity (KW)	0.2	0.4	0.75
Rated output current (A)	1.8	2.6	4.3
Rated capacity (KVA)	0.68	1.00	1.65
Input voltage range(V)	Single Phase : 100~120V,50/60HZ		
Allowable voltage fluctuation	+10%-15%		
Output voltage range(V)	Three phase 0~240V		
Input current (A)*	9.5	13	19
Allowable momentary power loss time (S)	1.0	1.0	1.0
Enclosure	IP20		

200V Class : Single phase.

F : Standards for built-in filter

Model : L510-□□□-H1-N (A) (L510-□□□-H1F-P (A))	2P2	2P5	201	202	203
Horse power (HP)	0.25	0.5	1	2	3
Suitable motor capacity (KW)	0.2	0.4	0.75	1.5	2.2
Rated output current (A)	1.8	2.6	4.3	7.5	10.5
Rated capacity (KVA)	0.68	1.00	1.65	2.90	4.00
Input voltage range(V)	Single Phase : 200~240V,50/60HZ				
Allowable voltage fluctuation	+10%-15%				
Output voltage range(V)	Three phase 0~240V				
Input current (A)	4.9	7.2	11	15.5	21
Allowable momentary power loss time (S)	1.0	1.0	1.0	2.0	2.0
Enclosure	IP20				

200V Class : Three phase

Model L510-□□□-H3-N (A)	2P2	2P5	201	202	203
Horse power (HP)	0.25	0.5	1	2	3
Suitable motor capacity (KW)	0.2	0.4	0.75	1.5	2.2
Rated output current (A)	1.8	2.6	4.3	7.5	10.5
Rated capacity (KVA)	0.68	1.00	1.65	2.90	4.00
Input voltage range(V)*	Three phase : 200~240V,50/60HZ				
Allowable voltage fluctuation	+10%-15%				
Output voltage range(V)	Three phase 0~240V				
Input current (A)	3.0	4.0	6.4	9.4	12.2
Allowable momentary power loss time(S)	1.0	1.0	1.0	2.0	2.0
Enclosure	IP20				

400V Class : Three phase.

F : Standards for built-in filter

Model : L510-□□□-H3-N A (L510-□□□-H3F-P A)	401	402	403
Horse power (HP)	1	2	3
Suitable motor capacity (KW)	0.75	1.5	2.2
Rated output current (A)	2.3	3.8	5.2
Rated capacity (KVA)	1.7	2.9	4.0
Input voltage range(V)	Three Phase : 380~480V,50/60HZ		
Allowable voltage fluctuation	+10%-15%		
Output voltage range(V)	Three phase 0~480V		
Input current (A)	4.2	5.6	7.3
Allowable momentary power loss time (S)	2.0	2.0	2.0
Enclosure	IP20		

*The input current is calculated value at full rated output current.

3.4.2 General Specifications

Item		L510
Control Mode		V/F Control + Auto-torque compensation function
Frequency	Range	0.01~650.00Hz
	Setting resolution	Digital input : 0.01Hz
		Analog input : 0.06Hz/60Hz
	Setting	Keypad : Set directly with ▲ ▼ keys or the VR (Potentiometer) on the keypad
		External Input Terminals: AVI(0/2~10V), ACI(0/4~20mA)input Multifunction input up/down function(Group3) Setting frequency by Communication method.
Frequency limit	Lower and upper frequency limits 3 -skip frequency settings.	
Run	Operation set	Keypad run, stop button
		External terminals: Multi- operation-mode 2 / 3 wire selection Jog operation
		Run signal by communication method.
Main Controls	V / F curve setting	6 fixed curve and one customized curve
	Carrier frequency	1~16KHz(default 5KHz)
	Acceleration and deceleration control	2 off Acc / dec time parameters. 4 off S curve parameters.
	Multifunction input	19 functions (refer to description on group3)
	Multifunction output	14 functions (refer to description on group3)
	Multifunction analog output	5 functions (refer to description on group4)
	Main features	Overload Detection, 8 preset speeds, Auto-run, Acc/Dec Switch (2 Stages), Main/Alt run Command select, Main/Alt Frequency Command select, PID control, torque boost, V/F start Frequency ,Fault reset.

Display	LED	Display: parameter/parameter value/frequency/line speed/DC voltage/output voltage/output current/PID feedback/input and output terminal status/Heat sink temperature/Program Version/Fault Log.
	LED Status Indicator	For run/stop/forward and reverse.
Protective Functions	Overload Protection	Integrated motor and Inverter overload protection.
	Over voltage	100V/200V : Over 410V, 400V : Over 820V
	Under voltage	100V/200V : Under 190V, 400V : Under 380V
	Momentary Power Loss Restart	Inverter auto-restart after a momentary power loss.
	Stall Prevention	Stall prevention for Acceleration/ Deceleration/ and continuous Run.
	Short-circuit output terminal	Electronic Circuit Protection
	Grounding Fault	Electronic Circuit Protection
	Additional protective functions	Heat sink over temperature protection, Auto carrier frequency reduction with temperature rise, fault output, reverse prohibit, Number of auto restart attempts, Parameter lock
International Certification		CE/UL
Communication		RS485 (Modbus) built in, with one to one or one to many control.
Environment	Operating temperature	-10~50°C
	Storage temperature	-20~60°C
	Humidity	Under 95%RH (no condensation)
	Shock	Under 20Hz, 1G(9.8m/s ²); 20~50Hz 0.6G(5.88m/s ²)
	EMC Compliance	EN61800-3, First Environment
	LVD Compliance	EN50178
	Electrical Safety	UL508C
	Protection level	IP20

3.5 Standard wiring

3.5.1 100V~200V Single phase (NPN input)

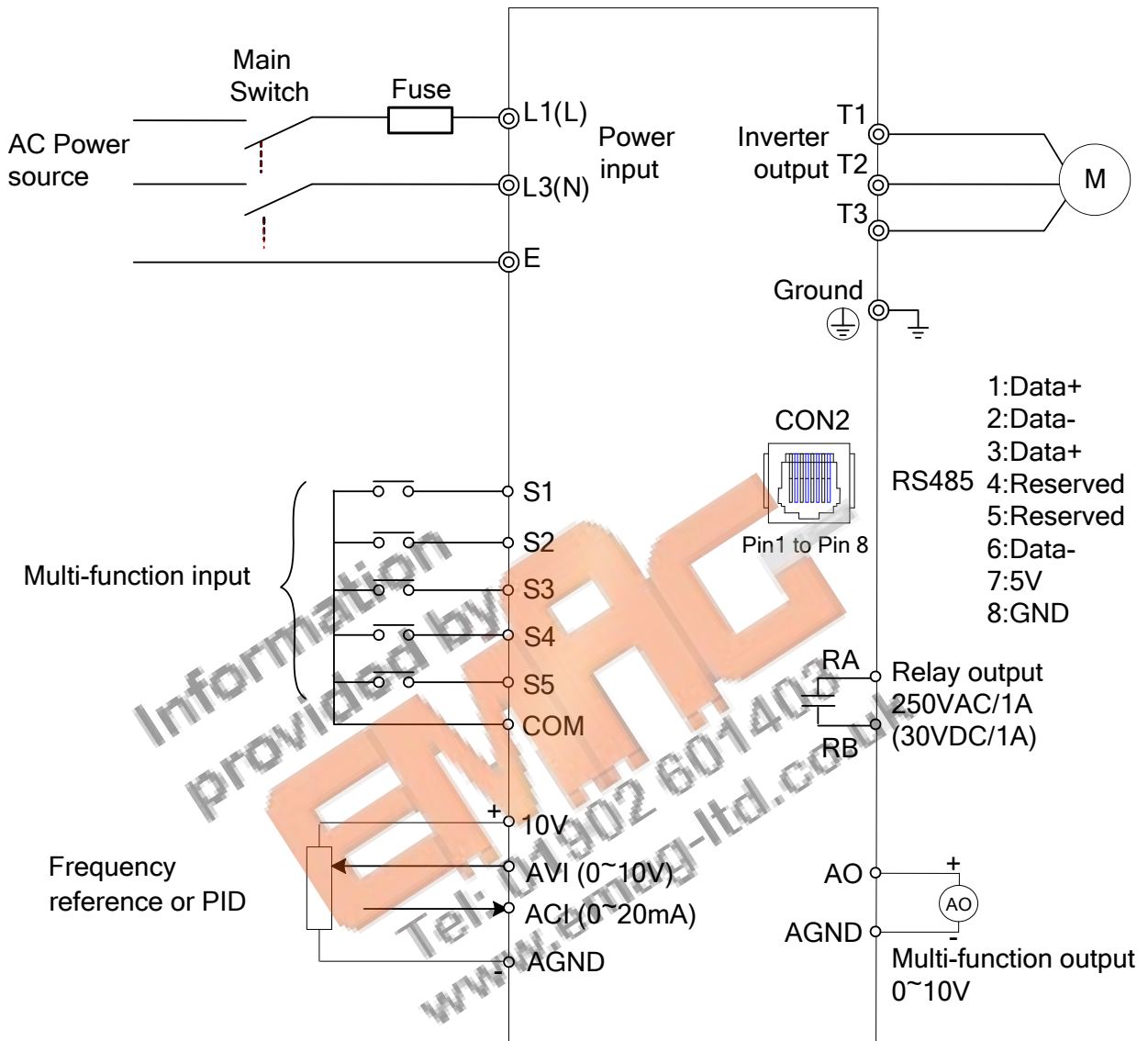

Model:

100V : L510-1P2-H1-N (A) / L510-1P5-H1-N (A) / L510-101-H1-N (A)

200V : L510-2P2-H1-N (A) / L510-2P5-H1-N (A) / L510-201-H1-N (A)

L510-202-H1-N (A) / L510-203-H1-N (A)

3.5.2 100V~200V Single phase (PNP input)

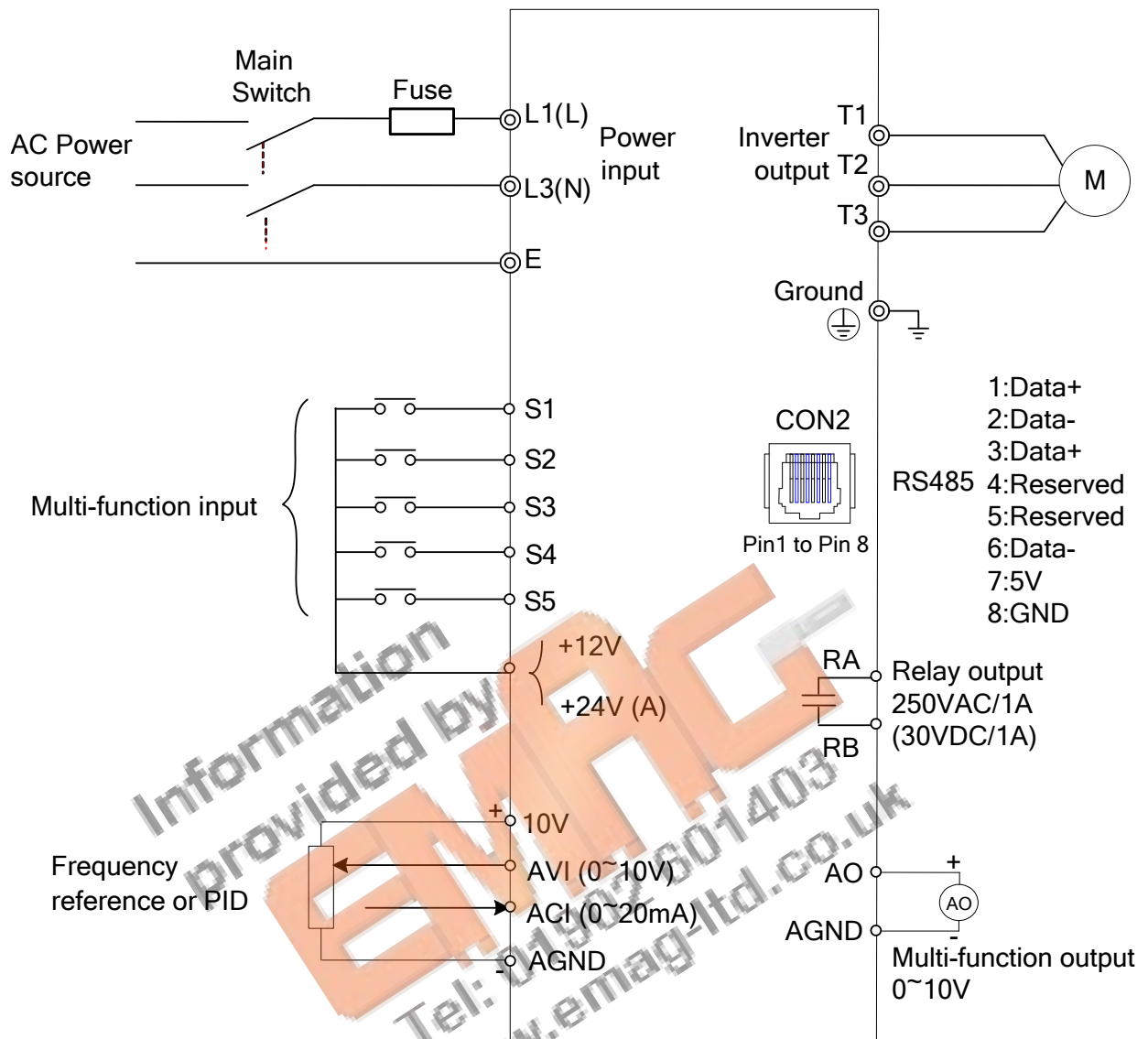

Model:

200V : L510-2P2-H1F-P (A) / L510-2P5-H1F-P (A) / L510-201-H1F-P (A)
 L510-202-H1F-P (A) / L510-203-H1F-P (A)

3.5.3 200V Three phase (NPN input)

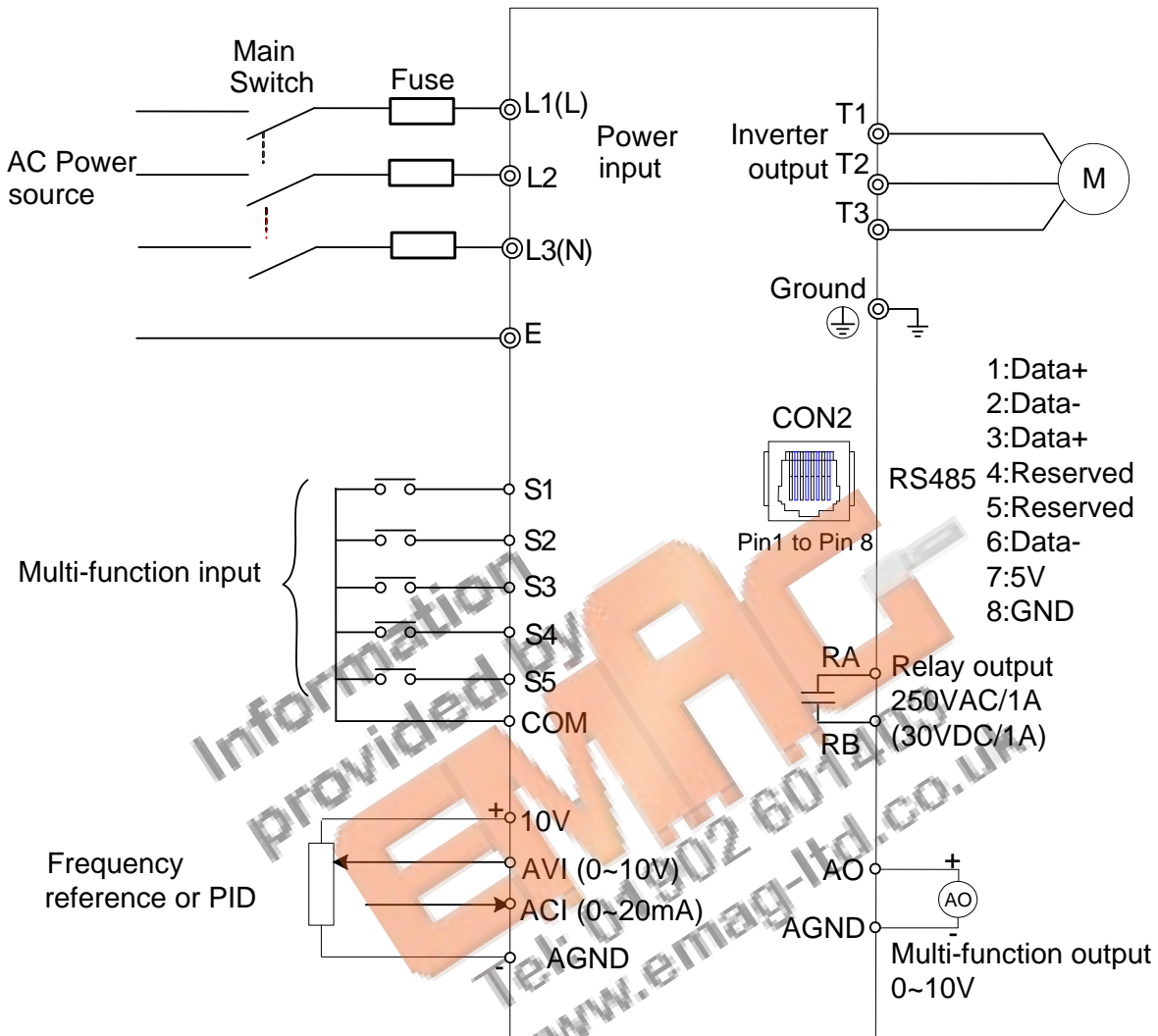

Model:

200V : L510-2P2-H3-N (A) / L510-2P5-H3-N (A) / L510-201-H3-N (A)
 L510-202-H3-N (A) / L510-203-H3-N (A)

3.5.4 400V Three phase (PNP input)

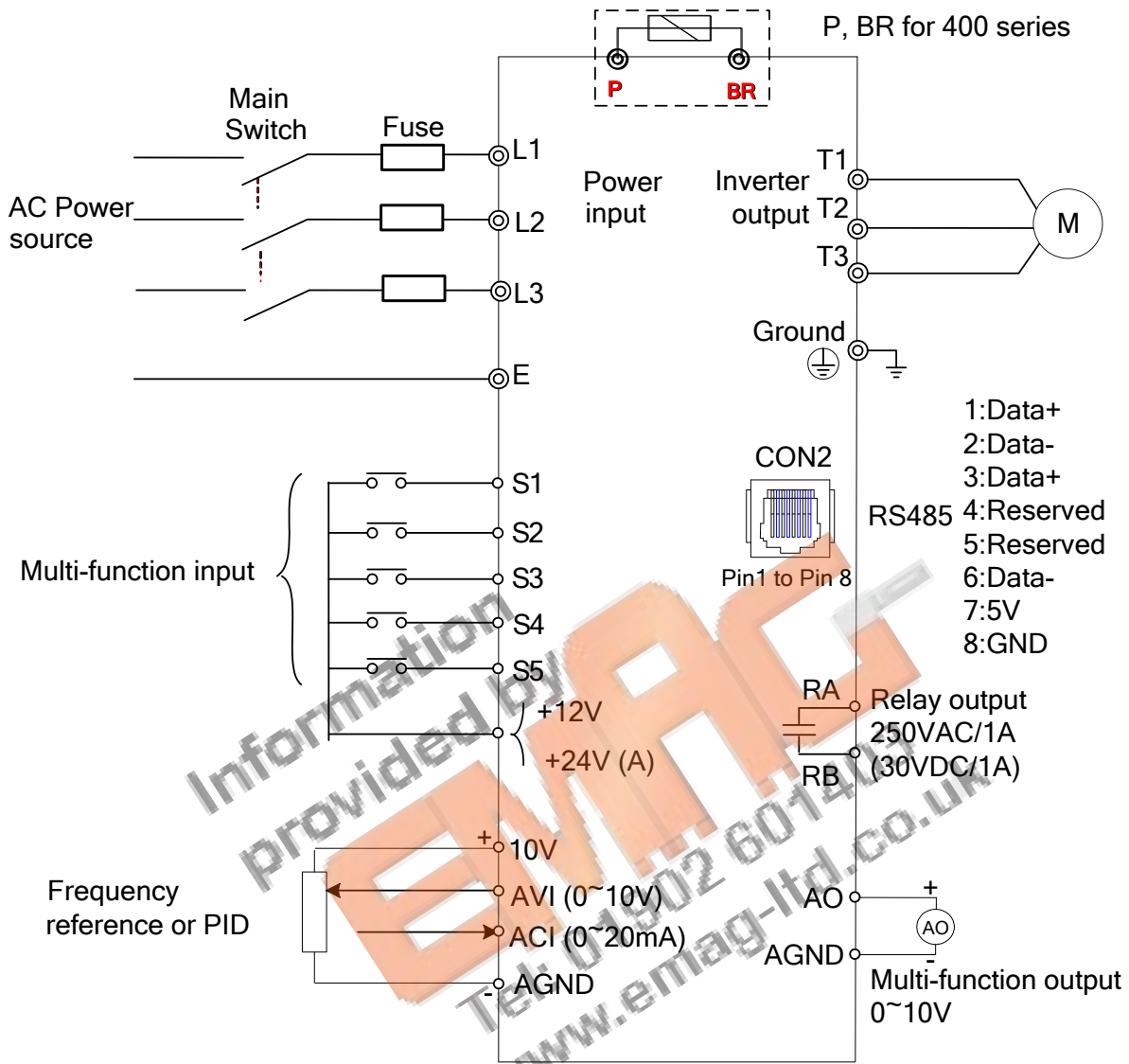

Model:

400V : L510-401-H3F-P A / L510-402-H3F-P A / L510-403-H3F-P A

3.6 Terminal Description

3.6.1 Description of main circuit terminals

Terminal symbols	TM1 Function Description
L1(L)	Main power input, L1(L)/L2/L3(N)
L2	
L3(N)	
P*	externally connected braking resistor
BR*	
T1	Inverter output, connect to U, V, W terminals of motor
T2	
T3	
	Ground terminal

*P, BR for 400V series

Single phase

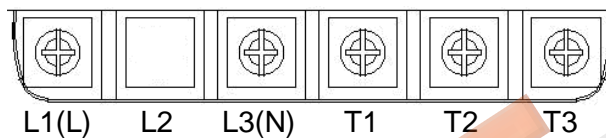

Note: the screw on L2 terminal is removed for the single phase input supply models.

Three phase

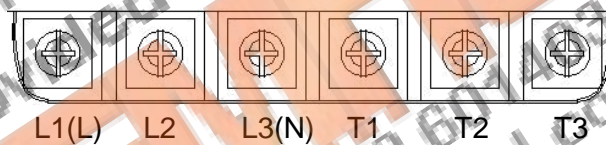

Three phase (400V series)

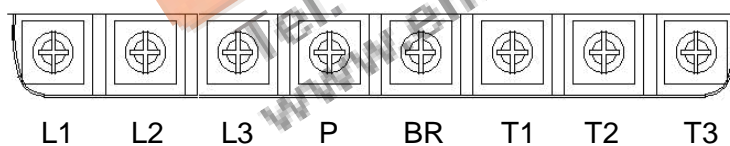

3.6.2 Control circuit terminal description

Terminal symbols	TM1 Function Description
RA	Relay output terminal, Specification: 250VAC/1A(30VDC/1A)
RB	
COM	S1~S5 (COMMON) 【NPN】
+12V / +24V	S1~S5 (COMMON) 【PNP】 (Model Name + A : 24V)
S1	Multi-function input terminals(refer to group3)
S2	
S3	
S4	
S5	
10V	Built in Power for an external speed potentiometer
AVI	Analog voltage input, Specification : 0~10VDC/ 2-10V
ACI	Analog current input, Specification : 0/4~20mA
AO	Multi function analog output terminal. Maximum output 10VDC/1mA
AGND	Analog ground terminal

NPN:

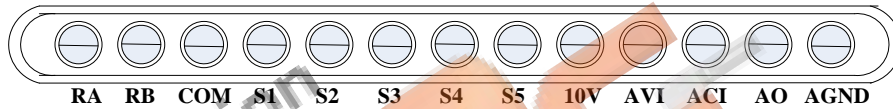

PNP:



3.7 Outline Dimensions

(unit: mm)

Frame1

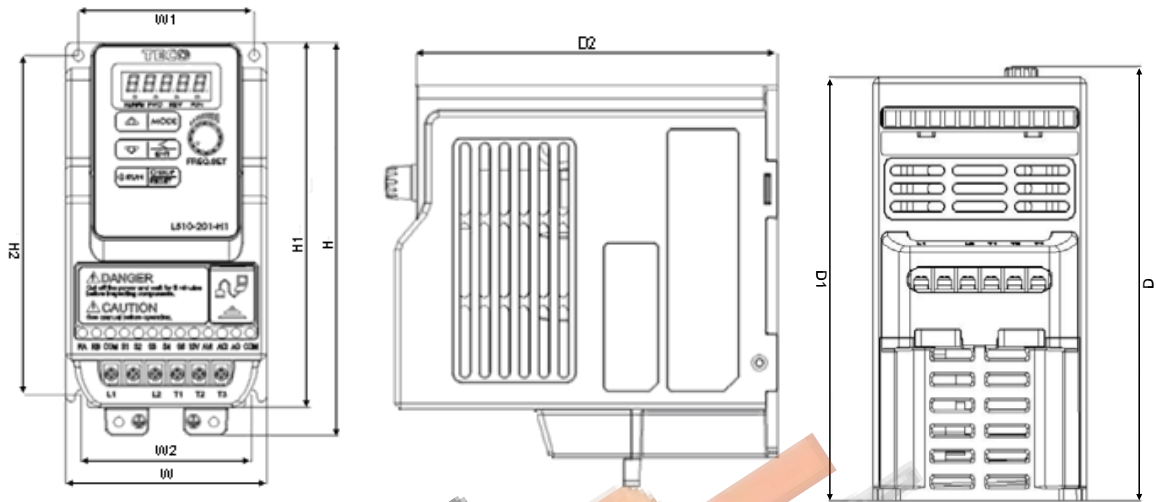

Unit : mm(inch)

Model	W	W1	W2	H	H1	H2	D	D1	Weight
L510-1P2-H1 (A)	72 (2.83)	63 (2.48)	61 (2.40)	141 (5.55)	131 (5.16)	122 (4.80)	144.2(5.69)	136 (5.35)	0.9kg
L510-1P5-H1 (A)									
L510-2P2-H1(F) (A)									
L510-2P5-H1(F) (A)									
L510-201-H1(F) (A)									
L510-2P2-H3 (A)									
L510-2P5-H3 (A)									
L510-201-H3 (A)									

F : Built-in EMC filter

Frame2

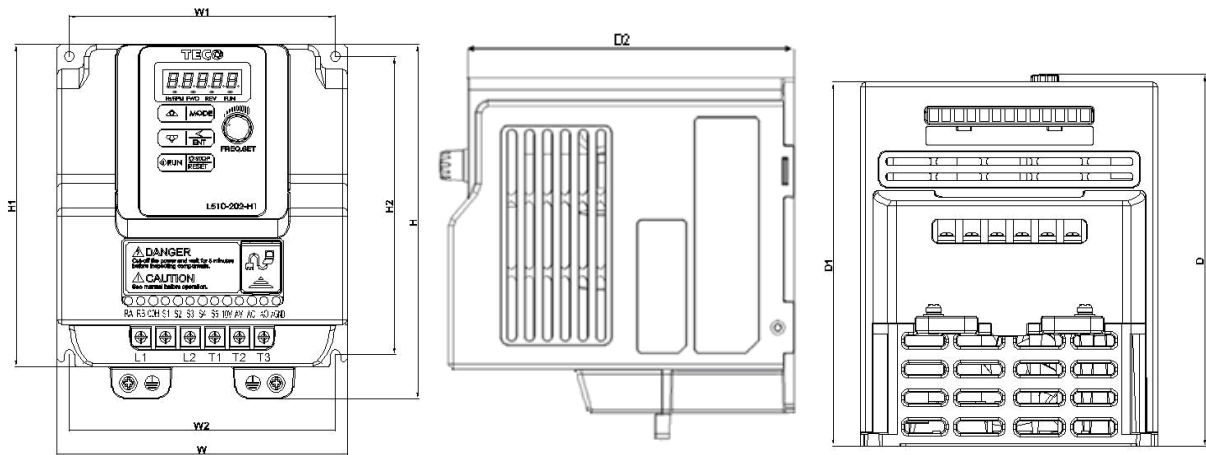

Unit : mm(inch)

Model	W	W1	W2	H	H1	H2	D	D1	Weight
L510-101-H1 (A)	118 (4.65)	108 (4.25)	108 (4.25)	144 (5.67)	131 (5.16)	121 (4.76)	152.25(6.01)	144.2 (5.68)	1.6kg
L510-202-H1(F) (A)									
L510-203-H1(F) (A)									
L510-202-H3 (A)									
L510-203-H3 (A)									
L510-401-H3(F) A									
L510-402-H3(F) A									
L510-403-H3(F) A									

F : Built-in EMC filter

Information provided by
EMAG
 Tel: 01902 601403
 www.emag-ltd.co.uk

3.8 EMC Filter Disconnection

EMC filter may be disconnected:

Inverter drives with built-in EMC filter are not suitable for connection to certain type of supply systems, such as listed below; in these cases the RFI filter can be disabled.

In all such cases consult your local electrical standards requirements.

IT type supply systems (ungrounded) & certain supply systems for medical equipment.

For ungrounded supply systems If the filter is not disconnected the supply system becomes connected to Earth through the Y capacitors on the filter circuit. This could result in danger and damage to the Drive.

Disconnection steps:

1. Remove EMC filter protection cover by screwdriver.
2. Remove EMC line by pliers.

Note:- Disconnecting the EMC filter link will disable the filter function, please consult your local EMC standards requirement..

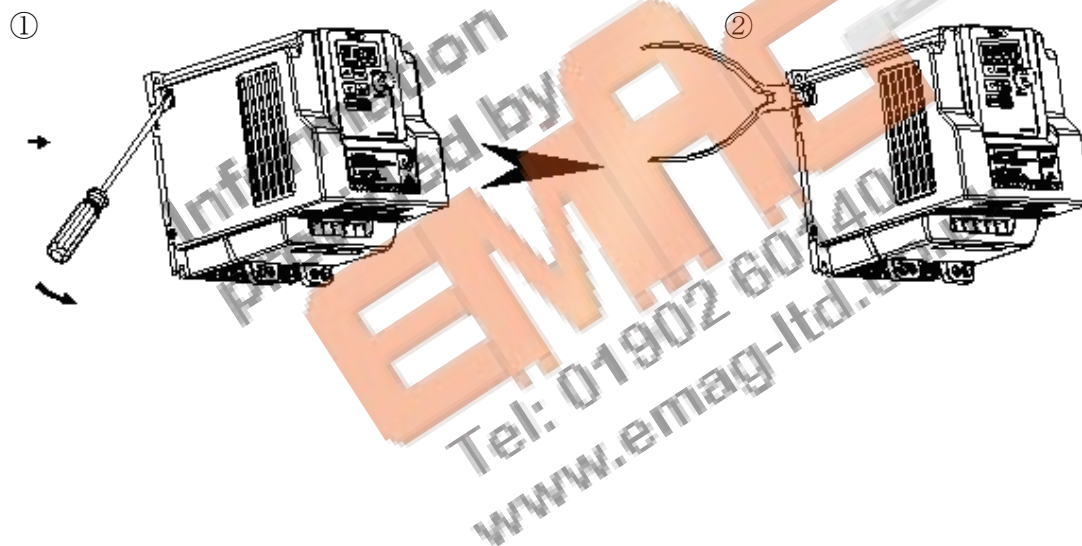

Chapter4 Software Index

4.1 Keypad Description

4.1.1 Operator Panel Functions



Type	Item	Function
Digital display & LEDs	Main digital displays	Frequency Display, Parameter, voltage, Current, Temperature, Fault messages.
	LED Status	Hz/RPM: ON when the frequency or line speed is displayed. OFF when the parameters are displayed. FWD: ON while the inverter is running forward. Flashes while stopped. REV: ON while the inverter is running reverse. Flashes while stopped. FUN: ON when the parameters are displayed. OFF when the frequency is displayed.
Variable Resistor	FREQ SET	Used to set the frequency
Keys On Keypad	RUN	RUN: Run at the set frequency.
	STOP/RESET (Dual function keys)	STOP: Decelerate or Coast to Stop. RESET: Use to Reset alarms or resettable faults.
	▲	Increment parameter number and preset values.
	▼	Decrement parameter number and preset values.
	MODE	Switch between available displays
	</ENTER (Dual function keys, a short press for left shift function, a long press for ENTER function)	<” Left Shift: Used while changing the parameters or parameter values ENTER: Used to display the preset value of parameters and for saving the changed parameter values.

4.1.2 Digital display Description

Alpha numerical display format

Digit	LED	Letter	LED	Letter	LED	Symbol	LED
0		A		n		-	
1		b		o		°	
2		C		P		_	
3		d		q		.	
4		E		r			
5		F		S			
6		G		t			
7		H		u			
8		J		v			
9		L		Y			

Digital display indication formats

Actual output frequency	Set frequency	
Digits are lit Continually	Preset digits flashing	Selected digit flashing

LED display examples

Display	Description
	In stop mode shows the set frequency In run mode shows the actual output frequency
	Selected Parameter
	Parameter Value
	Output Voltage
	Output Current in Amps
	DC Bus voltage
	Temperature
	PID feedback value
	Error display
	Analogue Current / Voltage ACID / AVI . Range (0~1000)

LED Status description

LED Indicator light Status	
Frequency / line speed Indicator	Hz/RPM On
Menu mode indicator	Fun On while not displaying frequency or line speed
FWD indicator	FWD On while running forward FWD Flashing while stopped in Forward mode.
REV indicator light	REV On while running reverse REV Flashing while stopped in Reverse mode

4.1.3 Digital display set up

On power up digital display screens will be as shown below.

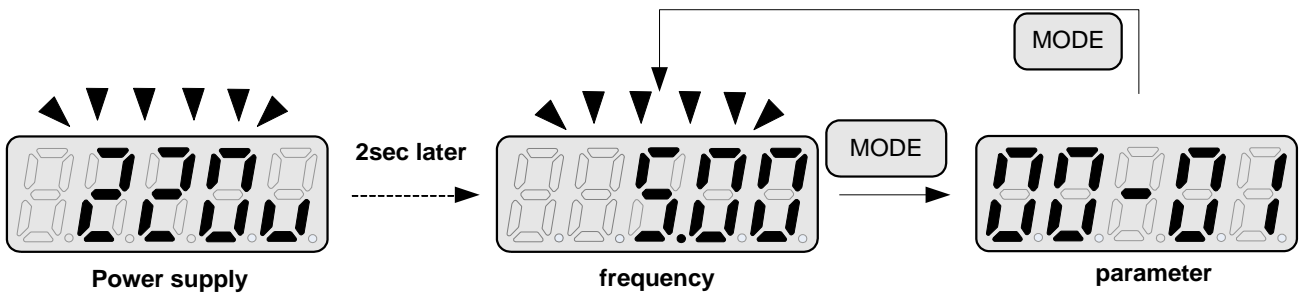

User selectable display formats:

12- 00	Display Mode								
	0 0 0 0 0								
	high Low								
	Each of the above 5 digits can be set to any of the selections below from 0 to 7								
Range	<table border="0"> <tr> <td>[0] :Disable display</td> <td>[1] :output Current</td> </tr> <tr> <td>[2] :output Voltage</td> <td>[3] :DC voltage</td> </tr> <tr> <td>[4] :Temperature</td> <td>[5] :PID feedback</td> </tr> <tr> <td>[6] :AVI</td> <td>[7] :ACI</td> </tr> </table>	[0] :Disable display	[1] :output Current	[2] :output Voltage	[3] :DC voltage	[4] :Temperature	[5] :PID feedback	[6] :AVI	[7] :ACI
[0] :Disable display	[1] :output Current								
[2] :output Voltage	[3] :DC voltage								
[4] :Temperature	[5] :PID feedback								
[6] :AVI	[7] :ACI								

The highest bit of 12-00 sets the power on the display, other bits set the selected display from range 0-7.as Listed above.

Example1: Set parameter 12- 00= [10000] to obtain display format shown below.

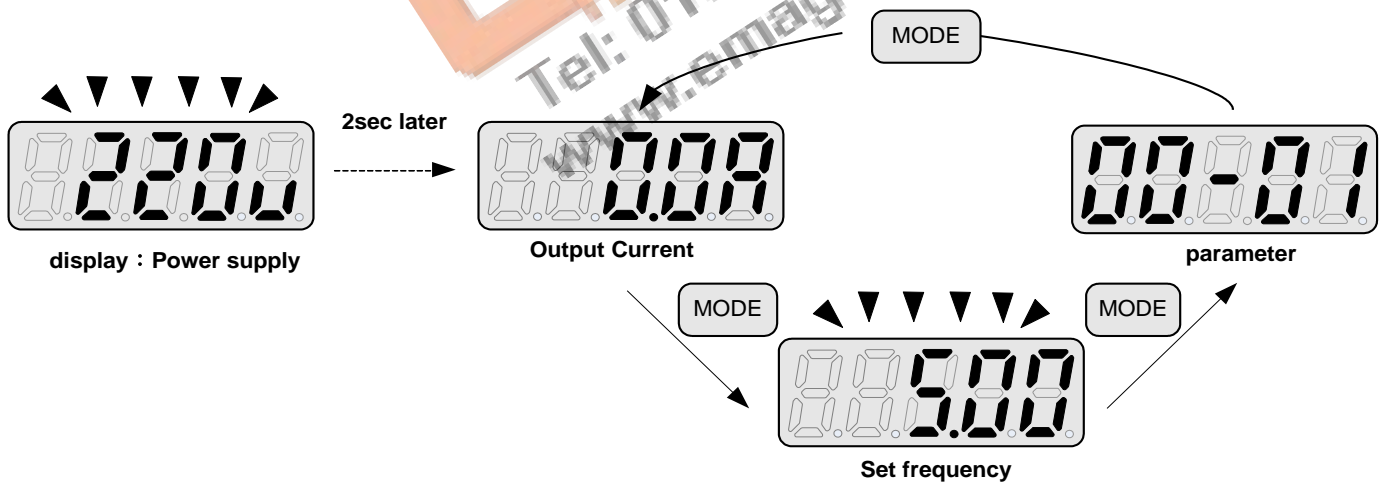

Example 2. Set parameter 2: 12- 00= [12345] to obtain the display format shown below.

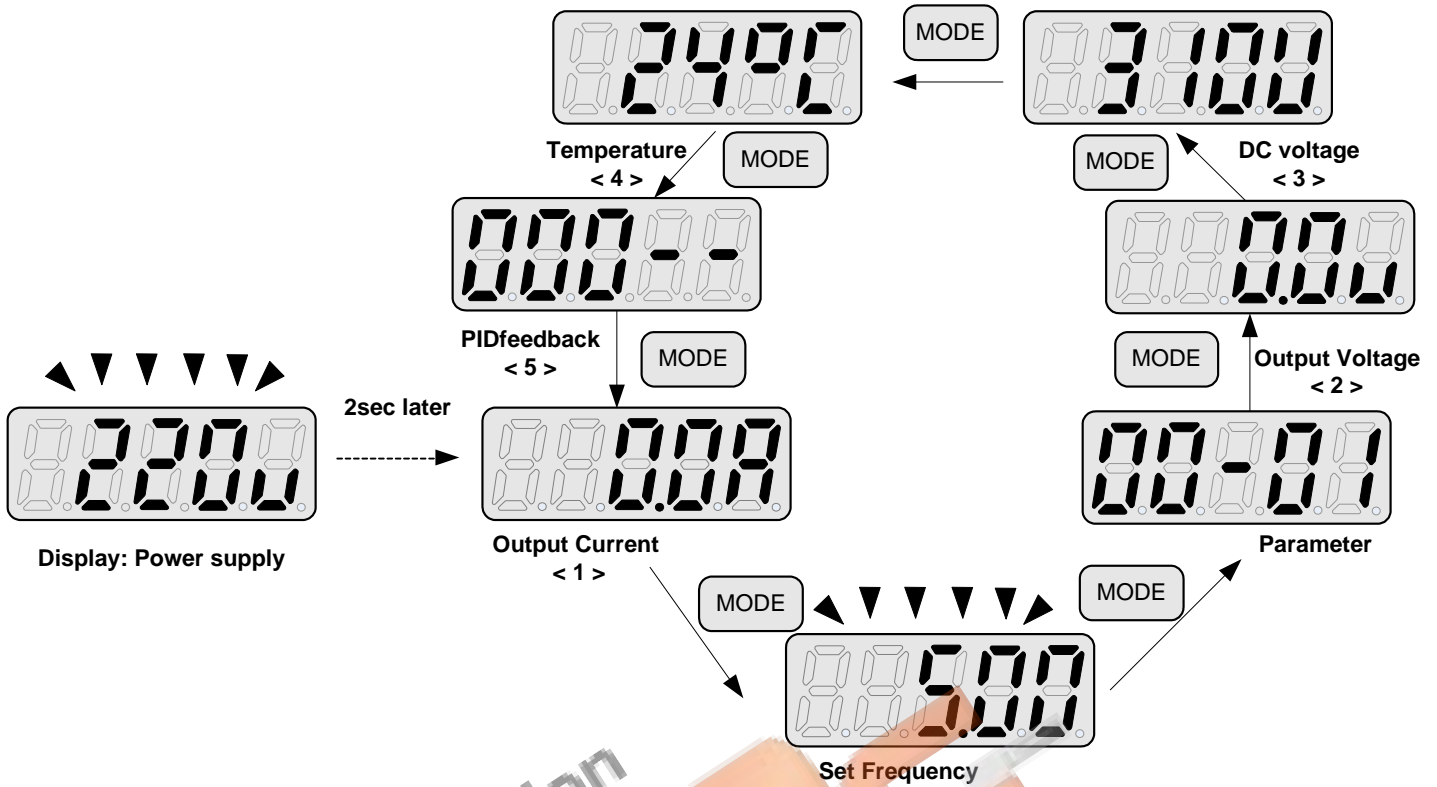

Increment/ Decrement key functions:

1. “▲”/“▼”:



Quick pressing of these keys will Increment or Decrement the selected digit by one. Extended pressing will Increment or Decrement the selected digit continuously.

2. “</ENT” Key functions :

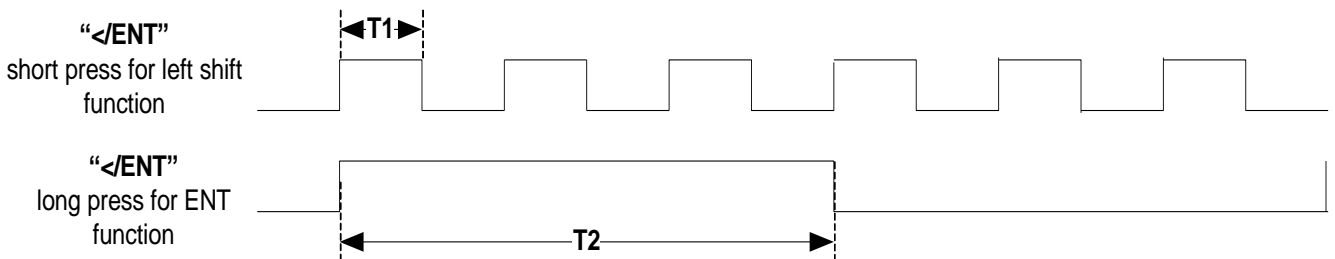

Quick pressing of this key will display the preset value of the parameter selected. Extended pressing of this key will save the altered value of the selected parameter.

4.1.4 Example of keypad operation

Example1: Modifying Parameters

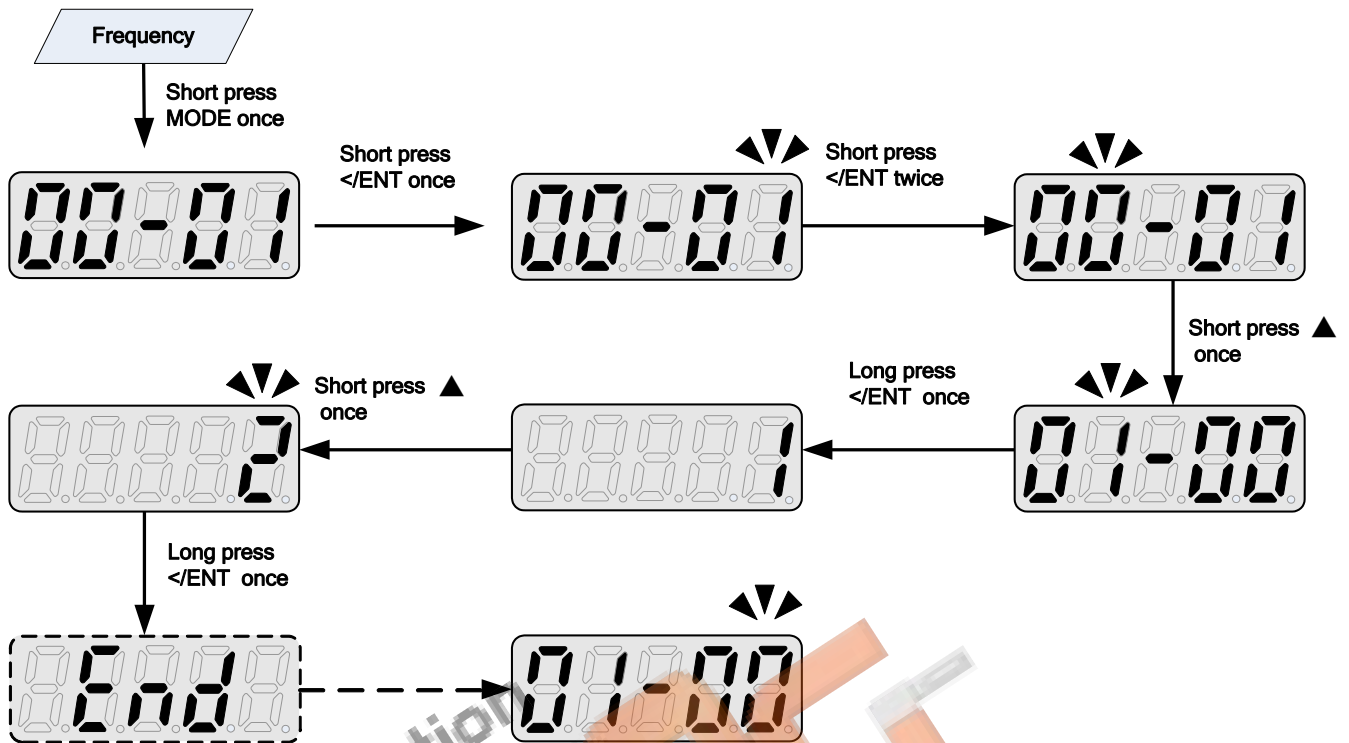

Information provided by
EMAG
Tel: 01902 601403
www.emag-ltd.co.uk

Example2: Modifying the frequency from keypad in run and stop modes.

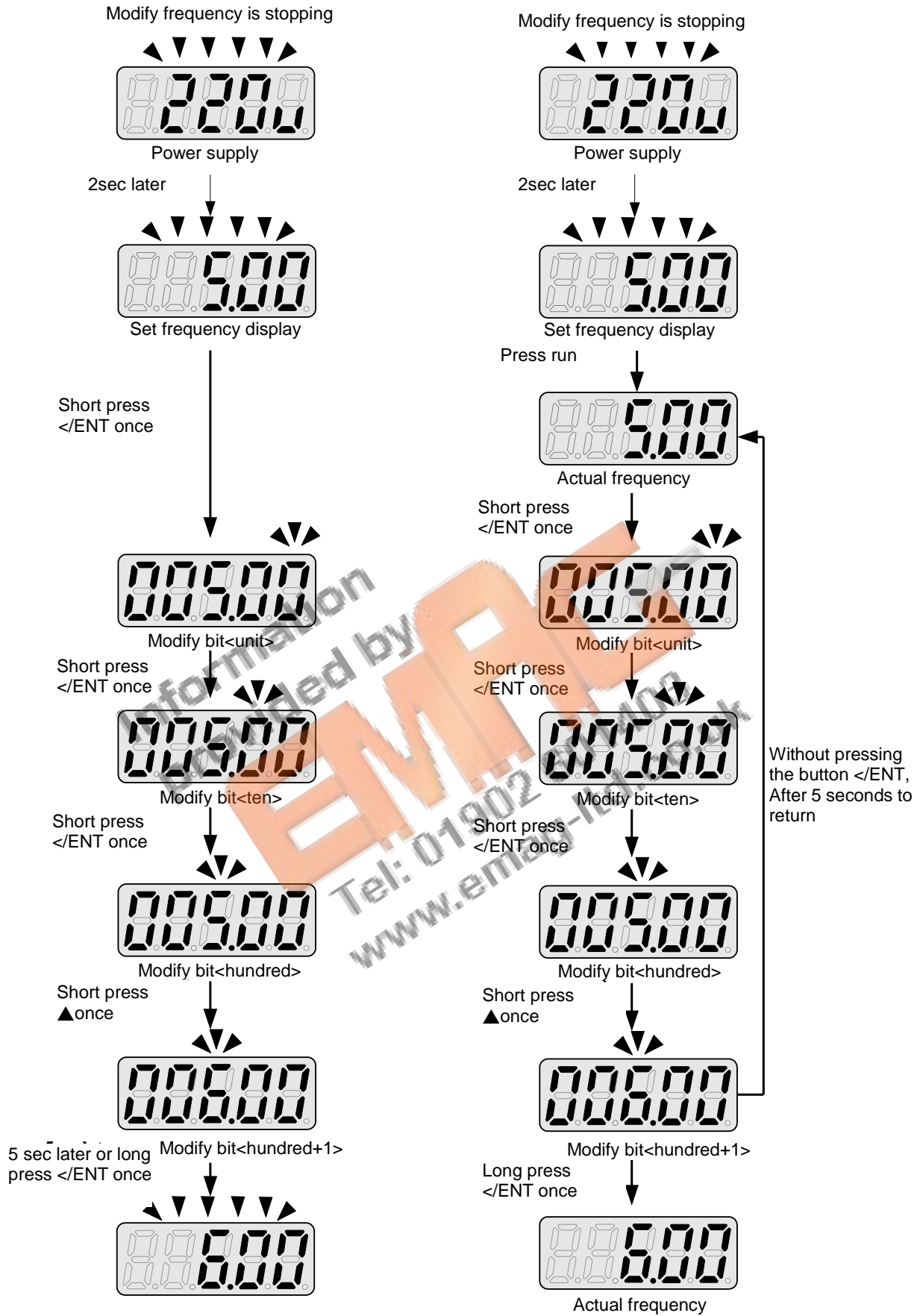

Note: frequency command setting will be limited to the range set by parameters for lower & upper frequency.

4.1.5 Operation Control

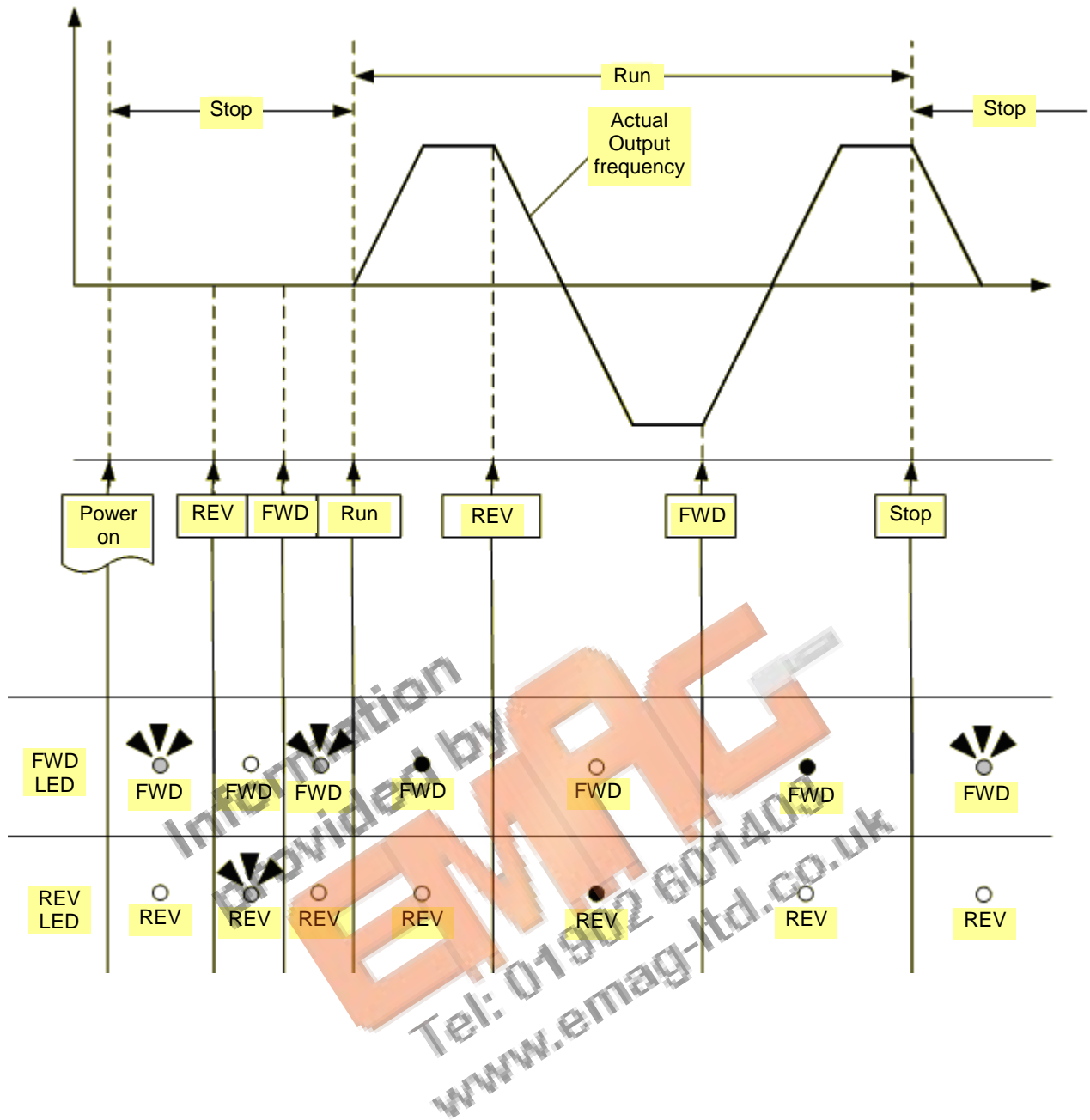

4.2 Programmable Parameter Groups

Parameter Group No.	Description
Group 00	Basic parameters
Group 01	V/F Pattern selections & setup
Group 02	Motor parameters
Group 03	Multi function digital Inputs/Outputs
Group 04	Analog signal inputs/ Analog output
Group 05	Preset Frequency Selections.
Group 06	Auto Run(Auto Sequencer) function
Group 07	Start/Stop command setup
Group 08	Drive and motor Protection
Group 09	Communication function setup
Group 10	PID function setup
Group 11	Performance control functions
Group 12	Digital Display & Monitor functions
Group 13	Inspection & Maintenance function

Parameter notes for Parameter Groups	
*1	Parameter can be adjusted during running mode
*2	Cannot be modified in communication mode
*3	Does not change with factory reset
*4	Read only

Group 00- The basic parameters group					
No.	Description	Range	Factory Setting	Unit	Note
00-00	Reserved				
00-01	Motor rotation	0:Forward 1:Reverse	0	-	*1
00-02	Main Run Source Selection	0:Keypad	0	-	
		1:External Run/Stop Control			
		2:Communication			
00-03	Alternative Run Source Selection	0:Keypad	0	-	
		1:External Run/Stop Control			
		2:Communication			
00-04	Operation modes for external terminals	0: Forward/Stop-Reverse/Stop	0	-	
		1: Run/Stop-Reverse/Forward			
		2: 3-Wire Control Mode-Run/Stop			
00-05	Main Frequency Source Selection	0:Keypad	0	-	
		1:Potentiometer on Keypad			
		2:External AVI Analog Signal Input			
		3:External ACI Analog Signal Input			
		4:External Up/Down Frequency Control			
		5:Communication setting Frequency			
6:PID output frequency					
00-06	Alternative Frequency Source Selection	0:Keypad	4	-	
		1:Potentiometer on Keypad			
		2:External AVI Analog Signal Input			
		3:External ACI Analog Signal Input			
		4:External Up/Down Frequency Control			
		5:Communication setting Frequency			
6:PID output frequency.					
00-07	Main and Alternative Frequency Command modes	0: Main Or Alternative Frequency 1: Main frequency+Alternative Frequency	0	-	
00-08	Communication Frequency Command	0.00~650.00		Hz	*4
00-09	Frequency command Save mode (Communication mode)	0:Save the frequency before power down 1:Save the communication frequency	0	-	
00-10	Initial Frequency Selection (keypad mode)	0:by Current Frequency Command	0	-	
		1:by 0 Frequency Command			
		2:by 00-11			
00-11	Initial Frequency Keypad mode	0.00~650.00	50.00/60.00	Hz	
00-12	Frequency Upper Limit	0.01~650.00	50.00/60.00	Hz	
00-13	Frequency Lower Limit	0.00~649.99	0.00	Hz	
00-14	Acceleration Time 1	0.1~3600.0	10.0	s	*1
00-15	Deceleration Time 1	0.1~3600.0	10.0	s	*1
00-16	Acceleration Time 2	0.1~3600.0	10.0	s	*1
00-17	Deceleration Time 2	0.1~3600.0	10.0	s	*1
00-18	Jog Frequency	1.00~25.00	2.00	Hz	*1
00-19	Jog Acceleration Time	0.1~25.5	0.5	s	*1
00-20	Jog Deceleration Time	0.1~25.5	0.5	s	*1

Group 01- V/F Pattern selection & Setup					
No.	Description	Range	Factory Setting	Unit	Note
01-00	Volts/Hz Patterns	1~7	1/4	-	
01-01	V/F Max voltage	200V:198.0~256.0 400V:323.0~528.0	220.0/440.0	Vac	
01-02	Max Frequency	0.20 ~ 650.00	50.00/60.00	Hz	
01-03	Max Frequency Voltage Ratio	0.0 ~ 100.0	100.0	%	
01-04	Mid Frequency 2	0.10 ~ 650.00	25.00/30.00	Hz	
01-05	Mid Frequency Voltage Ratio 2	0.0 ~ 100.0	50.0	%	
01-06	Mid Frequency 1	0.10 ~ 650.00	10.00/12.00	Hz	
01-07	Mid Frequency Voltage Ratio 1	0.0 ~ 100.0	20.0	%	
01-08	Min Frequency	0.10 ~ 650.00	0.50/0.60	Hz	
01-09	Min Frequency Voltage Ratio	0.0 ~ 100.0	1.0	%	
01-10	Volts/Hz Curve Modification (Torque Boost)	0 ~ 10.0	0.0	%	*1
01-11	V/F start Frequency	0.00~10.00	0.00	Hz	

Group 02- Motor parameters					
No.	Description	Range	Factory Setting	Unit	Note
02-00	Motor No Load Current	----		A	*3
02-01	Motor Rated Current (OL1)	----		A	
02-02	Motor rated Slip Compensation	0.0 ~ 100.0	0.0	%	*1
02-03	Motor Rated Speed	----		Rpm	
02-04	Motor Rated Voltage	----		Vac	*4

Group 03- Multi function Digital Inputs/Outputs					
No.	Description	Range	Factory Setting	Unit	Note
03-00	Multifunction Input Term. S1	0:Forward/Stop Command or Run /Stop	0	-	
03-01	Multifunction Input Term. S2	1:Reverse/Stop Command Or REV/FWD	1	-	
03-02	Multifunction Input Term. S3	2:Preset Speed 1 (5-02)	2	-	
03-03	Multifunction Input Term. S4	3:Preset Speed 2 (5-03)	3	-	
03-04	Multifunction Input Term. S5	4:Preset Speed 4 (5-05)	17	-	
		6:Jog Forward Command			
		7:Jog Reverse Command			
		8:Up Command			
		9:Down Command			
		10:Acc/Dec 2			
		11:Acc/Dec Disabled			
		12:Main/Alternative Run Command select			
		13:Main/Alternative Frequency Command select			
		14:Rapid Stop (Decel to stop)			
15:Base Block					
16:Disable PID Function					
17:Reset					
18:Auto Run Mode enable					
03-05	Reserved				
03-06	Up/Down frequency band	0.00~5.00	0.00	Hz	
03-07	Up/Down Frequency modes	0:When Up/Down is used, the preset frequency is held as the inverter stops, and the UP/Down function is disabled.	0	-	
		1:When Up/Down is used, the preset frequency is reset to 0 Hz as the inverter stops.			
		2:When Up/Down is used, the preset frequency is held as the inverter stops, and the UP/Down is available.			
03-08	S1~S5 scan confirmation	1~400. Number of Scan cycles	20	1ms	
03-09	S1~ S5 switch type select	xxxx0:S1 NO xxx1:S1 NC	00000	-	
		xxx0x:S2 NO xxx1x:S2 NC			
		xx0xx:S3 NO xx1xx:S3 NC			
		x0xxx:S4 NO x1xxx:S4 NC			
		0xxxx:S5 NO 1xxxx:S5 NC			
03-10	Reserved				
03-11	Output Relay(RY1)	0:Run	0	-	
		1:Fault			
		2:Setting Frequency Reached			
		3:Frequency Reached (3-13±3-14)			
		4:Output Frequency Detection1(> 3-13)			
		5:Output Frequency Detection2(< 3-13)			
		6:Auto-Restart			
		7:Momentary AC Power Loss			
		8:Rapid Stop			
		9:Base Block			
		10:Motor Overload Protection(OL1)			
		11:Drive Overload Protection(OL2)			
		12:Reserved			
13:Output Current Reached					

		14:Brake Control			
03-12		Reserved			
03-13	Output frequency detection level (Hz)	0.00~650.00	0.00	Hz	*1
03-14	Frequency Detection band	0.00~30.00	2.00	Hz	*1
03-15	Output Current Detection Level	0.1~15.0	0.1	A	
03-16	Output Current Detection Period	0.1~10.0	0.1	s	
03-17	External Brake Release level	0.00~20.00	0.00	Hz	
03-18	External Brake Engage Level	0.00~20.00	0.00	Hz	
03-19	Relay Output function type	0:A (Normally open) 1:B (Normally close)	0	-	

※ "NO" indicates normally open, "NC" indicates normally closed.

Group 04- Analog signal inputs/ Analogue output functions					
No.	Description	Range	Factory Setting	Unit	Note
04-00	AVI/ACI analog Input signal type select	AVI	ACI	0	-
		0:0~10V	0~20mA		
		1:0~10V	4~20mA		
		2:2~10V	0~20mA		
		3:2~10V	4~20mA		
04-01	AVI Signal Verification Scan rate	1~400	100	1ms	
04-02	AVI Gain	0 ~ 1000	100	%	*1
04-03	AVI Bias	0 ~ 100	0	%	*1
04-04	AVI Bias Selection	0: Positive 1: Negative	0	-	*1
04-05	AVI Slope	0: Positive 1: Negative	0	-	*1
04-06	ACI Signal Verification Scan rate	1~400	100	1ms	
04-07	ACI Gain	0 ~ 1000	100	%	*1
04-08	ACIBias	0 ~ 100	0	%	*1
04-09	ACI Bias Selection	0: Positive 1: Negative	0	-	*1
04-10	ACI Slope	0: Positive 1: Negative	0	-	*1
04-11	Analog Output mode(AO)	0: Output Frequency 1: Frequency Command 2: Output Voltage 3: DC Bus Voltage 4: Motor Current	0	-	*1
04-12	Analog Output AO Gain (%)	0 ~ 1000	100	%	*1
04-13	Analog Output AO Bias (%)	0 ~ 1000	0	%	*1
04-14	AO Bias Selection	0: Positive 1: Negative	0	-	*1
04-15	AO Slope	0: Positive 1: Negative	0	-	*1

Group 05- Preset Frequency Selections.					
No.	Description	Range	Factory Setting	Unit	Note
05-00	Preset Speed Control mode Selection	0: Common Accel/Decel Accel/Decel 1 or 2 apply to all speeds	0	-	
		1: Individual Accel/Decel Accel/ Decel 0-7 apply to the selected preset speeds (Acc0/Dec0~ Acc7/Dec7)			
05-01	Preset Speed 0 (Keypad Freq)	0.00 ~ 650.00	5.00	Hz	
05-02	Preset Speed1 (Hz)		5.00	Hz	*1
05-03	Preset Speed2 (Hz)		10.00	Hz	*1
05-04	Preset Speed3 (Hz)		20.00	Hz	*1
05-05	Preset Speed4 (Hz)		30.00	Hz	*1
05-06	Preset Speed5 (Hz)		40.00	Hz	*1
05-07	Preset Speed6 (Hz)		50.00	Hz	*1
05-08	Preset Speed7 (Hz)		50.00	Hz	*1
05-09 ~ 05-16	Reserved				
05-17	Preset Speed0-Acctime	0.1 ~ 3600.0	10.0	s	*1
05-18	Preset Speed0-Dectime		10.0	s	*1
05-19	Preset Speed1-Acctime		10.0	s	*1
05-20	Preset Speed1-Dectime		10.0	s	*1
05-21	Preset Speed2-Acctime		10.0	s	*1
05-22	Preset Speed2-Dectime		10.0	s	*1
05-23	Preset Speed3-Acctime		10.0	s	*1
05-24	Preset Speed3-Dectime		10.0	s	*1
05-25	Preset Speed4-Acctime		10.0	s	*1
05-26	Preset Speed4-Dectime		10.0	s	*1
05-27	Preset Speed5-Acctime		10.0	s	*1
05-28	Preset Speed5-Dectime		10.0	s	*1
05-29	Preset Speed6-Acctime		10.0	s	*1
05-30	Preset Speed6-Dectime		10.0	s	*1
05-31	Preset Speed7-Acctime		10.0	s	*1
05-32	Preset Speed7-Dectime		10.0	s	*1

Group 06- Auto Run(Auto Sequencer) function

No.	Description	Range	Factory Setting	Unit	Note
06-00	Auto Run (sequencer) mode selection	0: Disabled. 1: Single cycle. (Continues to run from the Unfinished step if restarted). 2: Periodic cycle. (Continues to run from the unfinished step if restarted). 3: Single cycle, then holds the speed Of final step to run. (Continues to run from the unfinished step if restarted). 4: Single cycle. (Starts a new cycle if restarted). 5: Periodic cycle. (Starts a new cycle if restarted). 6: Single cycle, then hold the speed of final step to run (Starts a new cycle if restarted).	0	-	
06-01	Auto _ Run Mode frequency command 1	0.00~650.00	0.00	Hz	*1
06-02	Auto _ Run Mode frequency command 2		0.00	Hz	*1
06-03	Auto _ Run Mode frequency command 3		0.00	Hz	*1
06-04	Auto _ Run Mode frequency command 4		0.00	Hz	*1
06-05	Auto _ Run Mode frequency command 5		0.00	Hz	*1
06-06	Auto _ Run Mode frequency command 6		0.00	Hz	*1
06-07	Auto _ Run Mode frequency command 7		0.00	Hz	*1
06-08 ~ 06-15	Reserved				
06-16	Auto_ Run Mode running time setting 0	0.0 ~ 3600.0	0.0	s	
06-17	Auto_ Run Mode running time setting 1		0.0	s	
06-18	Auto_ Run Mode running time setting 2		0.0	s	
06-19	Auto_ Run Mode running time setting 3		0.0	s	
06-20	Auto_ Run Mode running time setting 4		0.0	s	
06-21	Auto_ Run Mode running time setting 5		0.0	s	
06-22	Auto_ Run Mode running time setting 6		0.0	s	
06-23	Auto_ Run Mode running time setting 7		0.0	s	
06-24 ~ 06-31	Reserved				
06-32	Auto_ Run Mode running direction 0	0: Stop	0	-	
06-33	Auto_ Run Mode running direction 1	1: Forward 2: Reverse	0	-	

Group 06- Auto Run(Auto Sequencer) function					
No.	Description	Range	Factory Setting	Unit	Note
06-34	Auto_ Run Mode running direction 2		0	-	
06-35	Auto_ Run Mode running direction 3		0	-	
06-36	Auto_ Run Mode running direction 4		0	-	
06-37	Auto_ Run Mode running direction 5		0	-	
06-38	Auto_ Run Mode running direction 6		0	-	
06-39	Auto_ Run Mode running direction 7		0	-	

Group 07- Start/Stop command setup					
No.	Description	Range	Factory Setting	Unit	Note
07-00	Momentary Power Loss and Restart	0: Momentary Power Loss and Restart disable 1: Momentary power loss and restart enable	0	s	
07-01	Auto Restart Delay Time	0.0~800.0	0.0	s	
07-02	Number of Auto Restart Attempts	0~10	0	-	
07-03	Reset Mode Setting	0: Enable Reset Only when Run Command is Off 1: Enable Reset when Run Command is On or Off	0	-	
07-04	Direct Running After Power Up	0: Enable Direct run on power up 1: Disable Direct run on power up	1	-	
07-05	Delay-ON Timer	1.0~300.0	1.0	s	
07-06	DC Injection Brake Start Frequency (Hz) In Stop mode	0.10 ~ 10.00	1.5	Hz	
07-07	DC Injection Brake Level (%) In stop mode	0 ~20	5	%	
07-08	DC Injection Brake Time (Seconds) In stop mode	0.0 ~ 25.5	0.5	s	
07-09	Stopping Method	0: Deceleration to stop 1: Coast to stop	0		

Group 08- Drive & Motor Protection functions					
No.	Description	Range	Factory Setting	Unit	Note
08-00	Trip Prevention Selection	xxxx0: Enable Trip Prevention During Acceleration xxxx1: Disable Trip Prevention During Acceleration xxx0x: Enable Trip Prevention During Deceleration xxx1x: Disable Trip Prevention During Deceleration xx0xx: Enable Trip Prevention in Run Mode xx1xx: Disable Trip Prevention in Run Mode x0xxx: Enable over voltage Prevention in Run Mode x1xxx: Disable over voltage Prevention in Run Mode	00000	-	
08-01	Trip Prevention Level During Acceleration (%)	50 ~ 200	200	Inverter	
08-02	Trip Prevention Level During Deceleration (%)	50 ~ 200	200	Rated	
08-03	Trip Prevention Level In Run Mode (%)	50 ~ 200	200	Current 100%	
08-04	over voltage Prevention Level in Run Mode	350~390	380	VDC	
08-05	Electronic Motor Overload Protection Operation Mode	0: Disable Electronic Motor Overload Protection 1: Enable Electronic Motor Overload Protection	1	-	
08-06	Operation After Overload Protection is Activated	0: Coast-to-Stop After Overload Protection is Activated 1: Drive Will Not Trip when Overload Protection is Activated (OL1)	0	-	
08-07	Over heat Protection (cooling fan control)	0: Auto (Depends on temp.) 1: Operate while in RUN mode 2: Always Run 3: Disabled	1	-	
08-08	AVR Function (Auto Voltage Regulation)	0: AVR function enable 1: AVR function Disable 2: AVR function disable for stop 3: AVR function disable for deceleration 4: AVR function disable for stop and deceleration. 5: When VDC>(360V/740V), AVR function disable for stop and deceleration.	4	-	
08-09	Input phase lost protection	0: Disabled 1: Enabled	0	-	

Group 09- Communication function setup					
No.	Description	Range	Factory Setting	Unit	Note
09-00	Assigned Communication Station Number	1 ~ 32	1	-	*2*3
09-01	RTU code /ASCII code select	0:RTU code 1:ASCII code	0	-	*2*3
09-02	Baud Rate Setting (bps)	0:4800 1:9600 2:19200 3:38400	2	bps	*2*3
09-03	Stop Bit Selection	0:1 Stop Bit 1:2 Stop Bits	0	-	*2*3
09-04	Parity Selection	0:Without Parity 1:With Even Parity 2:With Odd Parity	0	-	*2*3
09-05	Data Format Selection	0: 8-Bits Data 1: 7-Bits Data	0	-	*2*3
09-06	Communication time-out detection time	0.0 ~ 25.5	0.0	s	
09-07	Communication time-out operation selection	0:Deceleration to stop (00-15: Deceleration time 1) 1:Coast to stop 2: Deceleration to stop (00-17: Deceleration time 2) 3: continue operating	0	-	
09-08	Error 6 verification time.	1 ~ 20	3		
09-09	Drive Transmit delay Time (ms)	5 ~ 65	5	ms	

Group10- PID function Setup					
No.	Description	Range	Factory Setting	Unit	Note
10-00	PID target value selection (when 00-05\00-06=6 ,this function is enabled)	0:Potentiometer on Keypad 1: Analog Signal Input. (AVI) 2: Analog Signal Input. (ACI) 3: Frequency set by communication 4: KeyPad Frequency parameter 10-02	1	-	*1
10-01	PID feedback value selection	0:Potentiometer on Keypad 1: Analog Signal Input. (AVI) 2: Analog Signal Input. (ACI) 3: Frequency set by communication	2	-	*1
10-02	PID Target (keypad input)	0.0~100.0	50.0	%	*1
10-03	PID Mode Selection	0:Disabled 1: Deviation D Control. FWD Characteristic. 2: Feedback D Control FWD Characteristic. 3: Deviation D Control Reverse Characteristic. 4: Feedback D Control Reverse Characteristic.	0	-	
10-04	Feedback Gain Coefficient	0.00 ~ 10.00	1.00	%	*1
10-05	Proportional Gain	0.0 ~ 10.0	1.0	%	*1
10-06	Integral Time	0.0 ~ 100.0	10.0	s	*1
10-07	Derivative Time	0.00 ~ 10.00	0.00	s	*1
10-08	PID Offset	0: Positive 1: Negative	0	-	*1
10-09	PID Offset Adjust	0 ~ 109	0	%	*1
10-10	PID Output Lag Filter Time	0.0 ~ 2.5	0.0	s	*1
10-11	Feedback Loss Detection Mode	0: Disabled 1: Enabled - Drive Continues to Operate After Feedback Loss 2: Enabled - Drive "STOPS" After Feedback Loss	0	-	
10-12	Feedback Loss Detection Level	0 ~ 100	0	%	
10-13	Feedback Loss Detection Delay Time	0.0 ~25.5	1.0	s	
10-14	Integration Limit Value	0 ~ 109	100	%	*1
10-15	Integral Value Resets to Zero when Feedback Signal Equals the Target Value	0:Disabled 1: 1 Second 30: 30 Seconds (0 ~ 30)	0	-	
10-16	Allowable Integration Error Margin (units)(1 unit = 1/8192)	0 ~ 100	0	-	
10-17	PID Sleep Frequency Level	0.00~650.00	0.00	Hz	
10-18	PID Sleep Function Delay Time	0.0 ~25.5	0.0	s	
10-19	PID Wake up frequency Level	0.00 ~ 650.00	0.00	Hz	
10-20	PID Wake up function Delay Time	0.0 ~ 25.5	0.0	s	
10-21	Max PID Feedback Setting	0 ~999	100	-	*1
10-22	Min PID Feedback Setting	0 ~999	0	-	*1

Group11- Performance Control functions					
No.	Description	Range	Factory Setting	unit	Note
11-00	Reverse operation control	0: Reverse command is enabled 1: Reverse command is disabled	0	-	
11-01	Carrier Frequency (kHz)	1~16	5	KHz	
11-02	Carrier mode Selection	0: Mode0, 3phase PWM modulation 1: Mode1, 2phase PWM modulation 2: Mode2, 2phase random PWM modulation	0	-	
11-03	Carrier Frequency Reduction by temperature rise	0:disabled 1:enabled	0	-	
11-04	S-Curve Acc 1	0.0 ~ 4.0	0.00	s	
11-05	S-Curve Acc 2	0.0 ~ 4.0	0.00	s	
11-06	S-Curve Dec 3	0.0 ~ 4.0	0.00	s	
11-07	S-Curve Dec 4	0.0 ~ 4.0	0.00	s	
11-08	Skip Frequency 1	0.00 ~ 650.00	0.00	Hz	*1
11-09	Skip Frequency 2	0.00 ~ 650.00	0.00	Hz	*1
11-10	Skip Frequency 3	0.00 ~ 650.00	0.00	Hz	*1
11-11	Skip Frequency Bandwidth (±)	0.00 ~ 30.00	0.00	Hz	*1

Group12 Digital Display & Monitor functions					
No.	Description	Range	Factory Setting	Unit	Note
12-00	Extended Display Mode	00000 ~77777. Each digit can be set to 0 to 7	00000	-	*1
		0: Default display (frequency¶meters)			
		1:Output Current			
		2:Output Voltage			
		3:DC voltage			
		4:Temperature			
		5:PID feedback			
		6:Analog Signal Input. (AVI) 7:Analog Signal Input. (ACI)			
12-01	PID Feedback Display format	0: Integer (xxx)	0	-	*1
		1:One decimal Place (xx.x)			
		2:Two Decimal Places (x.xx)			
12-02	PID Feedback Display Unit Setting	0:xxx--	0	-	*1
		1:xxxpb (pressure)			
		2:xxxfl (flow)			
12-03	Custom Units (Line Speed) Value	0~65535	1500/1800	RPM	*1
12-04	Custom Units (Line Speed) Display Mode	0:Drive Output Frequency is Displayed	0	-	*1
		1:Line Speed. Integer.(xxxxx)			
		2:Line Speed..One Decimal Place (xxxx.x)			
		3:Line Speed.Two Decimal Places (xxx.xx)			
		4:Line Speed.Three Decimal Places (xx.xxx)			

Group12 Digital Display & Monitor functions					
No.	Description	Range	Factory Setting	Unit	Note
12-05	Inputs and output Logic status display (S1 to S5) & RY1		-----	-	*4

Group 13 Inspection & Maintenance functions					
No.	Description	Range	Factory Setting	unit	Note
13-00	Drive Horsepower Code	----	-	-	*3
13-01	Software Version	----	-	-	*3*4
13-02	Fault Log (Last 3 Faults)	----	-	-	*3*4
13-03	Accumulated Operation Time1 1	0~23	-	hour	*3
13-04	Accumulated Operation Time1 2	0~65535	----	day	*3
13-05	Accumulated Operation Time Mode	0:Time Under Power 1:Run Mode Time Only	0	-	*3
13-06	Parameter Lock	0: Enable all Functions 1: Preset speeds 05-01~05-08 cannot be changed 2: All Functions cannot be changed Except for Preset speeds 05-01~05-08 3: Disable All Function	0	-	
13-07	Parameter Lock Code	00000~65535	00000	-	
13-08	Reset Drive to Factory Settings	1150: Reset to factory setting. 50Hz system. 1160: Reset to factory setting. 60Hz system.	00000	-	

4.3 Parameter Function Description

00- Basic parameter group

00- 01	Motor Direction Control
Range	【0】 : Forward 【1】 : Reverse

➤ 00 - 01 Is valid in key pad mode only.

※Note: When Reverse function is disabled by parameter 11- 00=1 setting 00-01 to 1 ." LOC" will be displayed

00- 02	Main Run Command Source selection
00- 03	Alternative Run Command Source selection
Range	【0】 : Keypad 【1】 : External Run/Stop Control 【2】 : Communication

➤ Parameter 00 - 02/00- 03 sets the inverter operation command source. For switching between 00-02 and 00-03, use any of the external inputs S1 to S5 and set the relevant parameters (03-00~03-04) to [12]. refer to parameter group3.

00- 04	Operation modes for external terminals
Range	【0】 : Forward/stop-reverse/stop 【1】 : Run/stop-forward/reverse 【2】 : 3-wire control mode -run/stop

➤ 00-04 Is valid when Run command is set to External mode by 00- 02/00- 03 =1.

2-wire operation mode:

Set 00-04= 【0/1】 first, before setting (03-00,03-04) to[0] or [1]

00-04= 【0】 Set external terminals (03-00 to 03-04) function to 0 for FWD/Stop or Set to 1 for REV/Stop.

00-04= 【1】 Set external terminals (03-00 to 03-04) function to 0 for Run/Stop or Set to 1 for FWD/REV.

3-wire operation mode:

00-04 = 【2】 Terminals S1, S2, S3 are used in a combination to enable 3 wire run/stop mode.

Settings for 03-00, 03-01, 03-02 will not be effective. (refer to Group 03)

00- 05	Main Frequency Command Source Selection
00- 06	Alternative Frequency Command Source Selection
Range	【0】 :UP/DOWN of Keypad 【1】 :Potentiometer on Keypad 【2】 :External AVI Analog Signal Input 【3】 :External ACI Analog Signal Input 【4】 :External Up/Down Frequency Control 【5】 :Communication setting Frequency 【6】 :PID Output frequency

➤ When 00-06 =[6], frequency command source is output of the PID.

00- 07	Main and Alternative Frequency Command Modes
---------------	---

Range	【0】 :Main Or Alternative Frequency. 【1】 :Main frequency + Alternative Frequency
--------------	--

➤ When 00-07= **【0】** , the frequency source is set by the **Main frequency** parameter 00-05 (Default) or by the **Alternative frequency** parameter 00-06.

Use any of the external terminals S1 to S5 and set the relevant parameter 03-00 to 03-04 = **【13】** to switch from **main** to **Alternative** source.

➤ When 00 - 07 = **【1】** The Frequency command will be the result of setting of Main & alternative frequencies.

00- 08	Communication Frequency Command
Range	【0.00~650.00】 Hz

- This parameter can be used to set frequency command
- This parameter can be used to read the set frequency in communication mode
- This parameter is only effective in the communication mode.

00- 09	Frequency Command save on power down (Communication mode)
Range	【0】 :disable 【1】 :enable

- 00-09= **【0】** Keypad frequency is saved.
- 00-09= **【1】** **Frequency set by communication is saved.**

00-10	Initial Frequency Selection
Range	【0】 :By Current Freq Command 【1】 :By Zero Freq Command 【2】 :By 00-11
00-11	Initial Frequency Setpoint
Range	【0.00~650.00】 Hz

- This parameter is **only** effective in keypad mode..
- When 00-10= **【0】** ,the initial frequency will be current frequency.
- When 00-10= **【1】** ,the initial frequency will be 0.
- When 00-10= **【2】** ,the initial frequency will be as set by parameter 00-11.

00-12	Frequency Upper limit
Range	【0.01~650.00】 Hz
00-13	Frequency Lower limit
Range	【0.00~649.99】 Hz

- When 00-13 and the command frequency are both set to 0.00, if RUN is pressed " Stpo" is displayed.
- When Frequency command is > than preset in 00-13 inverter output will ramp up from 0.00 to the command frequency.
- When 00-13> 0, and the frequency command value ≤ 00-13, inverter output will ramp up from preset in lower limit to the command frequency.

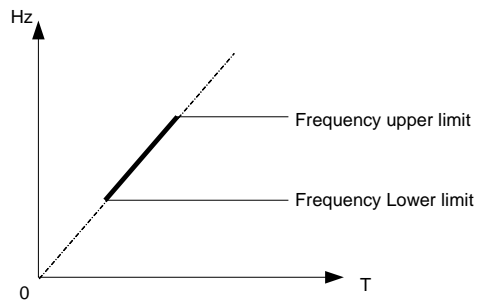

00-14	Acceleration time 1
Range	【0.1~3600.0】 s
00-15	Deceleration time 1
Range	【0.1~3600.0】 s
00-16	Acceleration time 2
Range	【0.1~3600.0】 s
00-17	Deceleration time 2
Range	【0.1~3600.0】 s

- Preset Acceleration and Deceleration times by above parameters are the time taken for the output frequency to ramp up or ramp down between the Upper and the lower frequency limits.
- Actual acceleration and deceleration time is calculated as follows:

$$\text{Actual acceleration time} = \frac{(00-14) \times (\text{set frequency} - \text{the minimum starting frequency})}{\text{Maximum output frequency}}$$

$$\text{Actual deceleration time} = \frac{(00-15) \times (\text{set frequency} - \text{the minimum starting frequency})}{\text{Maximum output frequency}}$$

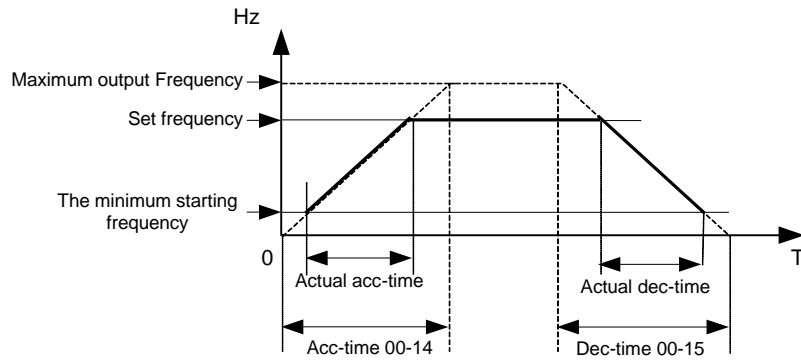

Maximum output frequency is for VF curve, which can be checked from table when VF curve is fixed. Maximum output frequency is 01-02 when VF curve is customized.

00-18	Jog Frequency
Range	【1.00~25.00】 Hz
00-19	Jog Acceleration Time
Range	【0.1~3600.0】 s
00-20	Jog Deceleration Time
Range	【0.1~3600.0】 s

- The JOG function is operational by using the multi-function input terminals S1 to S5 and setting the relevant parameters 03-00~03-04 to **【6】 JOG FWD** or **【7】 JOG REV**. Refer to parameter group 3.

Information provided by
EMAG
 Tel: 01902 601403
 www.emag-ltd.co.uk

01-V/F command group	
01- 00	Volts/Hz Patterns (V/F)
Range	【1~7】

- Set 01-00 to one of the following preset V/f selections 【1~6】 according to the required application.
- Parameters 01-02~01-09 are not applicable.
- Six fixed V/f patterns are shown below. 【1~3】 for 50 Hz systems and 【4~6】 for 60 Hz.

TYPE	50Hz		60Hz	
Function	01-00	V/F pattern	01-00	V/F pattern
General Use	= 【1】		= 【4】	
High start torque	= 【2】		= 【5】	
Decreasing torque	= 【3】		= 【6】	

- (V) 100% is the maximum output voltage. B, C point preset % settings will be as table below:-

01- 00	B(Xb)	C(Xc)
1/4	10%	8%
2/5	15%	10.5%
3/6	25%	7.7%

- Setting 01-00 =[7] provides a flexible V/F curve which can be selected by experienced users by

setting parameters (01-02~01-09).

01- 01	v/f Maximum voltage
Range	200: 【198.0~256.0】 V 400: 【323.0~528.0】 V
01- 02	Maximum Frequency
Range	【0.20 ~ 650.00】 Hz
01- 03	Maximum Frequency Voltage Ratio
Range	【0.0 ~ 100.0】 %
01- 04	Medium Frequency 2
Range	【0.10 ~ 650.00】 Hz
01- 05	Medium Frequency Voltage Ratio 2
Range	【0.0 ~ 100.0】 %
01- 06	Medium Frequency 1
Range	【0.10 ~ 650.00】 Hz
01- 07	Medium Frequency Voltage Ratio 1
Range	【0.0 ~ 100.0】 %
01- 08	Minimum Frequency
Range	【0.10 ~ 650.00】 Hz
01- 09	Minimum Frequency Voltage Ratio
Range	【0.0 ~ 100.0】 %

- Max output frequency depends on parameter 01-00 , for 01-00= **【7】** It can be set by parameter 01-02.
- For 01-00 ≠ **【7】** , the maximum output frequency depends on parameter 00-12, frequency upper limit.

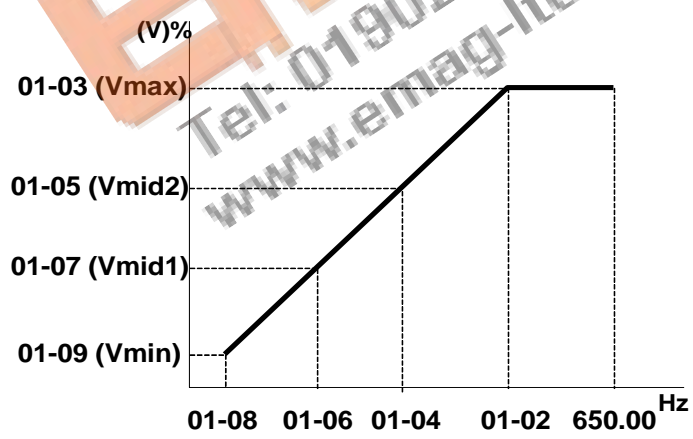

01-10	Volts/Hz Curve Modification (Torque Boost)
Range	【0 ~ 10.0】 %

- Inverter output V / F curve settings for points B, C can be adjusted by parameter 01-10 to improve the output torque.
- Calculation of B, C point voltage: B point voltage = $X_b \times$ maximum output voltage, C point voltage = $X_c \times$ maximum output voltage (X_b, X_c see Page 4-26). When 01-10 = 0, the torque improvement is disabled.

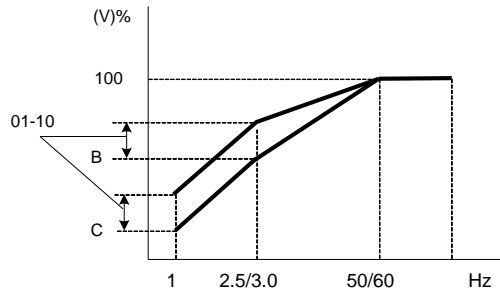

01-11	V/F start Frequency
Range	【0.00 ~10.00】 Hz

VF Start Frequency is for occasion where Start Frequency higher than zero Hz is needed.

02- Motor parameter group

02- 00	Motor no load current
Range	----
02- 01	Motor Rated Current
Range	----
02- 02	Motor rated Slip Compensation
Range	【0.0 ~ 100.0】 (%)
02- 03	Motor Rated Speed
Range	----
02- 04	Motor Rated Voltage
Range	---

- When the load causes the actual motor speed to be reduced below the speed set by inverter output frequency (Slip) , parameter 02-02 Slip compensation can be used to correct the speed.

$$\text{Slip compensation boost} = \frac{\text{Output Current}-(02-00)}{(02-01)-(02-00)} \times (02-02) \times \text{Rate motor slip}$$

Motor slip = Motor synchronous speed- Motor Rated Speed

$$(02-02)\text{approximate Value} = \frac{\text{Motor synchronization speed}-\text{Rated speed}}{\text{Motor synchronization speed}}$$

Example: 4 poles, 60Hz induction motor synchronization speed = $\frac{120}{4} \times 60 = 1800(\text{RPM})$

※Note: 02- 00/02- 01 differs with the inverter capacities (13- 00),It should be regulated according to actual conditions.

03- External digital inputs & Realy Output functions

03- 00	Multifunction Input Term. S1
03- 01	Multifunction Input Term. S2
03- 02	Multifunction Input Term. S3
03- 03	Multifunction Input Term. S4
03- 04	Multifunction Input Term. S5
Range	<p>【0】 :Forward/Stop Command------(Parameters 00- 02/00-03=1 & 00-04)</p> <p>【1】 :Reverse/Stop Command------(Parameters 00-02/00-03=1 & 00-04)</p> <p>【2】 :Preset Speed 1 (5- 02)----- (Parameter Group5)</p> <p>【3】 :Preset Speed 2 (5- 03)------(Parameter Group5)</p> <p>【4】 :Preset Speed 4 (5- 05) ------(Parameter Group5)</p> <p>【6】 :JOG Forward Command------(Parameters 00-18~00-20)</p> <p>【7】 :JOG Reverse Command----- (Parameters 00-18~00-20)</p> <p>【8】 :Up Command----- (Parameters 00- 05/00- 06=4& 03-06/03-07)</p> <p>【9】 :Down Command----- (Parameters 00- 05/00- 06=4& 03-06/03-07)</p> <p>【10】 : 2nd Acc/Dec times</p> <p>【11】 : Disable Acc/Dec</p> <p>【12】 : Main/ Alternative run source Select------(Parameters 00- 02/00- 03)</p> <p>【13】 : Main/Alternative Frequency Command Select-----(Parameters 00- 05/00- 06)</p> <p>【14】 : Rapid Stop (controlled deceleration stop)</p> <p>【15】 : Base Block (Coast to stop)</p> <p>【16】 : Disable PID Function.------(Parameter Goup10)</p> <p>【17】 : Reset</p> <p>【18】 : Enable Auto Run Mode------(Parameter Group 6)</p>

Various example settings and descriptions for Parameters 03-00 to 03-04 are noted in the following pages seconds from 1 to 13.

1) For setting parameters 03- 00~03- 04 to **【0, 1】** External Run/Stop Control, refer to 00- 04.

2-wire method. Mode 1.

Example: FWD/STOP and REV/STOP from two inputs (S1&S2)

Set 00- 04= **【0】** , S1: 03- 00= **【0】** (FWD/STOP) , S2: 03- 01= **【1】** (REV/STOP);

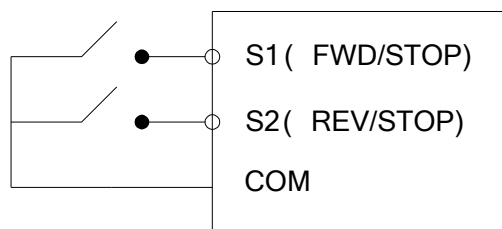

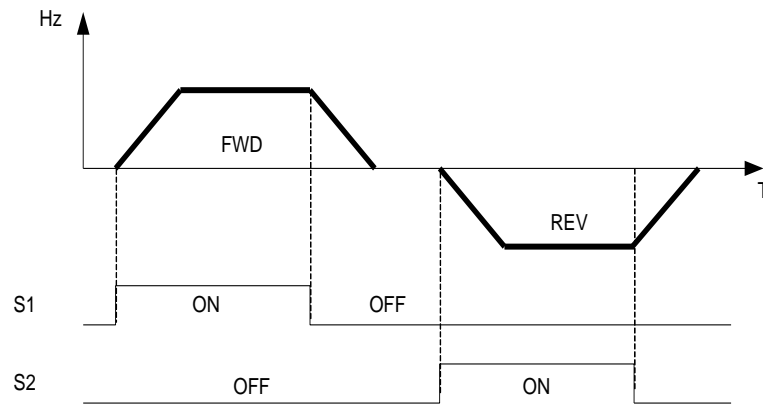

※ **Note:** If both forward and reverse commands are ON, it will be treated as a STOP.

Information
 provided by
EMAG
 Tel: 01902 601403
 www.emag-ltd.co.uk

2-wire method. Mode 2.

Example: RUN/STOP and REV/FWD from two inputs (S1&S2)

Set 00- 04= [1] ; S1: 03- 00= [0] (RUN/STOP); S2:03- 01= [1] (REV/FWD);

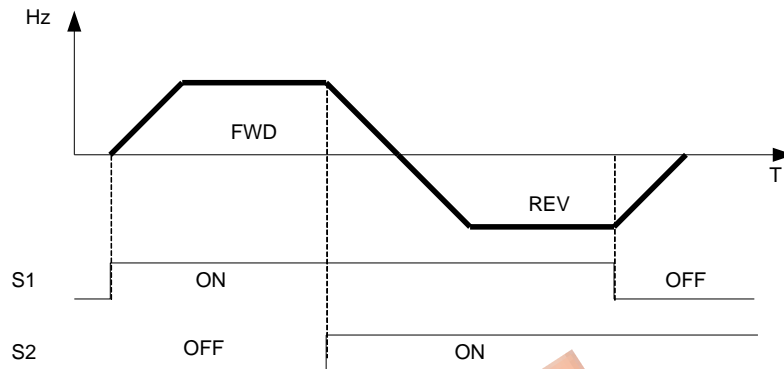
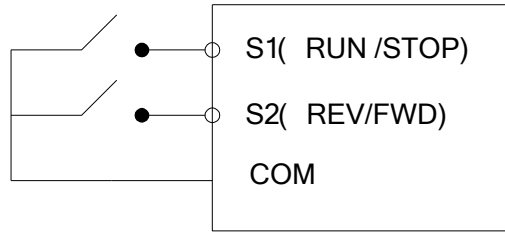

3-wire method.

Example:- Two separate push buttons for RUN & STOP and a two position switch for FWD/ REV

Set 00- 04 =2.(3 wire control mode), then terminals S1, S2 and S3 are dedicated to this function and Preset selections for parameters 03-00, 03-01 and 03-02.are not relevant.

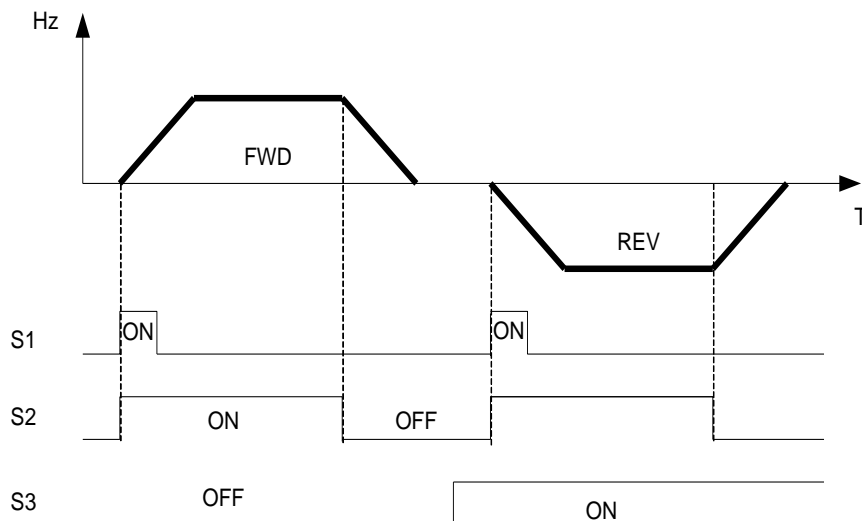
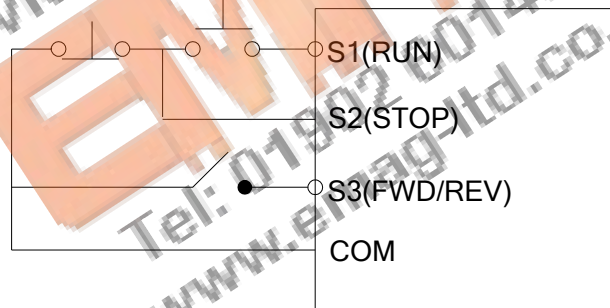

2) Parameters 03- 00~03- 04= **[4, 3, 2]** Preset speed selections.

Combination of any three terminals from S1~ S5 can be used to select preset speeds 0 to 7 according to the table below.

Preset speed 0-7 and the related acceleration/decelerating times should be set in parameter group 5. For example timing diagram refer to Group 5 description.

Preset speed	Function setting and state of any three (A,B,C) of terminal S1~S5			Frequency	Acc-time	Dec-time
	terminal A=4	terminal B =3	terminal C =2			
speed 0	OFF	OFF	OFF	05- 01	05- 17	05-18
speed 1	OFF	OFF	ON	05- 02	05- 19	05-20
speed 2	OFF	ON	OFF	05- 03	05- 21	05-22
speed 3	OFF	ON	ON	05- 04	05- 23	05-24
speed 4	ON	OFF	OFF	05- 05	05- 25	05-26
speed 5	ON	OFF	ON	05- 06	05- 27	05-28
speed 6	ON	ON	OFF	05- 07	05- 29	05-30
speed 7	ON	ON	ON	05- 08	05- 31	05-32

3) 03- 00~03- 04= **[6 ,7]** Forward/ Reverse JOG

When an input terminal is set to function **[6]** and is turned on, inverter will work in jog forward mode.

When an input terminal is set to function **[7]** and is turned on, inverter will work in jog reverse mode.

Note: If jog forward and jog reverse function is enabled at the same time, inverter will enter stop mode.

4) 03- 00~03- 04= **[8, 9]** UP/DOWN

When an input terminal is set to function **[8]** and is turned on, frequency command is increased according to the UP/DOWN, increment/decrement step set in parameter 03-06.

If the input is kept on continuously, the frequency command increases accordingly until the upper frequency limit is reached.

When an input terminal is set to function **[9]** and is turned on, frequency command decreases according to the UP/DOWN increment/decrement step set in parameter 03-06.

If the input is kept on continuously, the frequency command decreases accordingly and in relation to settings for parameter 03-06 and 3-07 until Zero speed is reached.

Refer to group 3 parameter description.

5) 03- 00~03- 04= **[10]** 2nd Acc/Dec time

When an input terminal is set to function **[10]** and is turned on, the actual acceleration and deceleration time will be according to the time for 2nd Accel/Decel set in parameters 00-16 and 00-17. If the input is turned off, the acceleration and deceleration times will be according to the default accel/decal 1 set in parameters 00-14 & 00-15.

6) 03- 00~03- 04= **[11]** Disable Acc/Dec function

When an input terminal is set to function **[11]** and is turned on, acceleration and deceleration function will be disabled and the frequency at the time is maintained. (constant speed mode)

If the input is turned off, acceleration and deceleration function is enabled again.

For an example see the following diagram.

Accel/Decel & Enable/Disable timing diagram using terminal S1 and parameter 03-00 = 11.

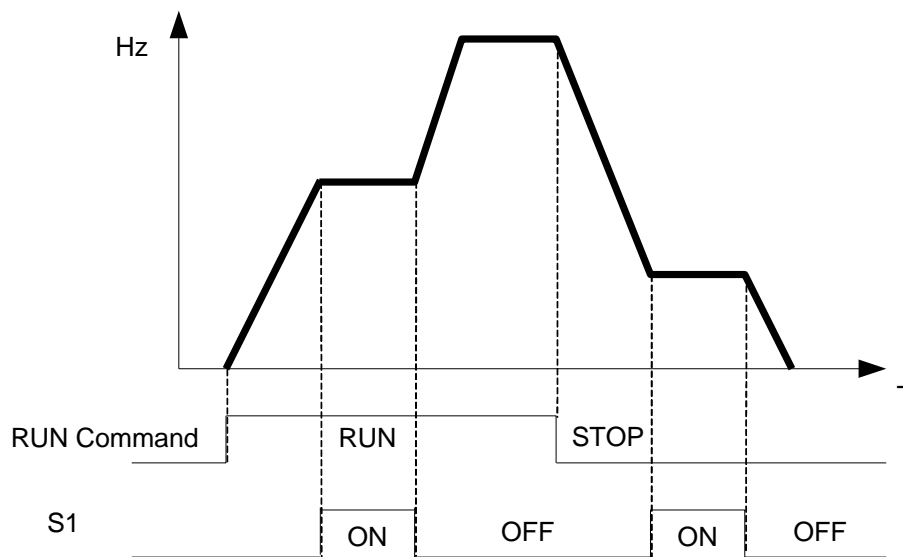

7) 03- 00~03- 04= 【12】 Main/ Alternative run source select.

When an input terminal is set to function 【12】 and is turned on, the run command source is according to parameter 00-03(Alternative Run source).If the Input is off it will be according to 00-02 (Main run source).

8) 03- 00~03- 04= 【13】 Main/ Alternative Frequency source Select

When an input terminal is set to function 【13】 and is turned on, the frequency source is according to parameter 00-06(Alternative Frequency source).If the Input is off it will be according to 00-05 (Main Frequency source).

9) 03- 00~03- 04= 【14】 Rapid Stop (controlled deceleration stop)

When an input terminal is set to function 【14】 and is turned on , inverter decelerates to stop.

10) 03- 00~03- 04= 【15】 Base Block (Coast to stop)

When an input terminal is set to function 【15】 and is turned on, inverter output is turned off.

11) 03- 00~03- 04= 【16】 Disable PID Function.

When an input terminal is set to function 【16】 and is turned on, PID functions is disabled, if it is turned off , PID function is enabled again.

12) 03- 00~03- 04= 【17】 Reset

When a failure that can be manually reset occurs, turn on a terminal with function 【17】 , the failure will be reset. (Same function as the Reset button on keypad).

13) 03- 00~03- 04= 【18】 Auto _ Run Mode

When an input terminal is set to function 【18】 , the programmable auto- sequencer function is enabled, Refer to description of parameter group 6.

03- 06	Up/Down frequency step
Range	【0.00~5.00】 Hz

Example: S1: 03- 00= 【8】 Up frequency command, S2: 03- 01= 【9】 Down frequency command, 03- 06= 【Δ】 Hz

Mode1: If UP or DOWN input terminals are turned on for less than 2 seconds, for every On operation frequency changes by Δ Hz.

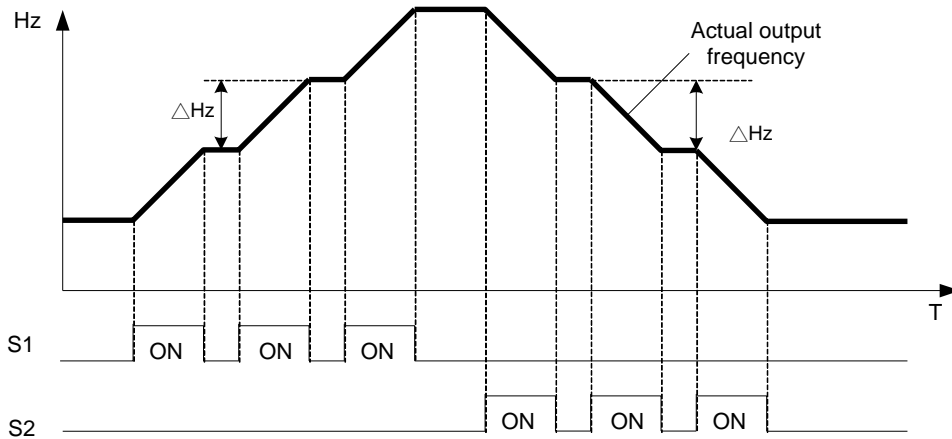

Mode 2: If UP or DOWN input terminals are turned on for more than 2 seconds, the original UP/DOWN mode is restored. Output frequency Ramps up or down as long as the input is kept ON.

As shown in the diagram below.

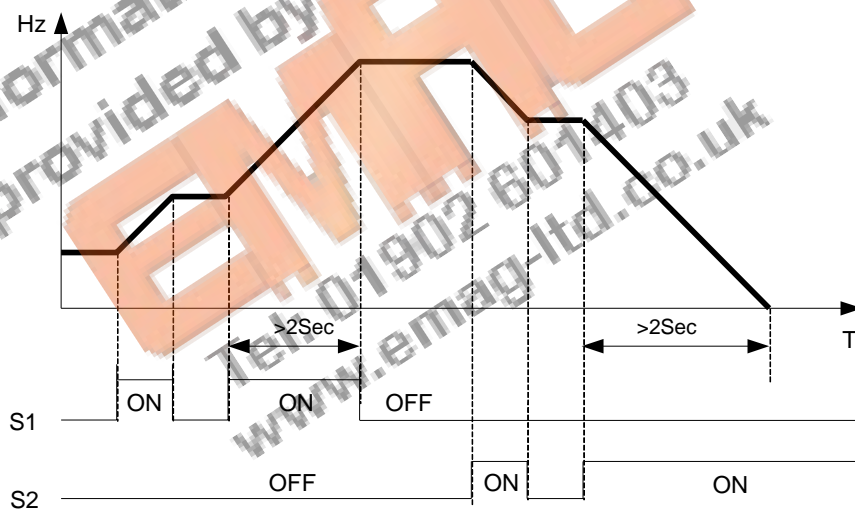

03- 07	Up/Down keep Frequency status after a stop command
Range	<p>【0】 : After a stop command in Up/Down mode, the preset frequency is held as the inverter stops, and the UP/Down function is disabled.</p> <p>【1】 : After a stop command in Up/Down mode, the preset frequency is reset to 0 Hz as the inverter stops.</p> <p>【2】 : After a stop command in Up/Down mode, the preset frequency is held as the inverter stops, and the UP/Down function remains enabled.</p>

- 03 - 07 = 【0】 , 【2】 When run signal is removed (Stop Command), the output frequency is stored in parameter 05-01(Key pad Frequency).
- 03 - 07 = 【0】 In stop mode since frequency can not be increased or decreased from Up/Down terminals then keypad can be used to change the frequency by modifying

parameter 05-01.

- 03 - 07 = **【1】** In Up/down frequency mode inverter will ramp up from 0Hz on Run command and Ramp down to 0 Hz on stop command.

Information
provided by
EMAG
Tel: 01902 601403
www.emag-ltd.co.uk

03- 08	Multifunction terminals S1~S5 scan time
Range	【1~200】 1m s

- Multifunction input terminal On/Off periods will be scanned for the number of cycles according to the set value in parameter 03-08. If the signal status for On or off period is less than the set period it will be treated as noise.
- Scan period unit is 1ms.
- Use this parameter if unstable input signal is expected, however setting long scan time periods results in slower response times.

03- 09	s1~s5 Input type selection NO & NC
Range	【xxxx0】 :S1 NO 【xxx1】 :S1 NC 【xxx0x】 :S2 NO 【xxx1x】 :S2 NC 【xx0xx】 :S3 NO 【xx1xx】 :S3 NC 【x0xxx】 :S4 NO 【x1xxx】 :S4 NC 【0xxxx】 :S5 NO 【1xxxx】 :S5 NC

- (NO) Normally open, (NC) Normally closed. Select as required.
- For selecting Normally Open (NO) or Normally Closed(NC) set the relevant digit in parameter 03-09 to 0 or 1 as required.
- Set Parameter 03-09 first before you use the Parameters 00-02/00-03=1 to set the inverter run mode to External multifunction inputs.

03-11	Multifunction Output Relay RY1 functions. (Terminals RB, RA)
Range	【0】 :Run 【1】 :Fault 【2】 :Setting Frequency Reached -----(refer to 03-14) 【3】 :Frequency Reached (3-13±3-14) -----(refer to 03-13/03-14) 【4】 :Output Frequency Detection 1 (> 03-13) -----(refer to 03-13) 【5】 :Output Frequency Detection 2 (< 03-13) -----(refer to 03-13) 【6】 :Auto-Restart 【7】 :Momentary AC Power Loss----- (refer to 07-00) 【8】 :Rapid Stop (Decelerate to Stop) 【9】 :Base Block 【10】 :Motor Overload Protection (OL1) 【11】 :Drive Overload Protection (OL2) 【12】 :Reserved 【13】 :Output Current Reached -----(refer to 03-15/03-16) 【14】 :Brake Control----- (refer to 03-17/03-18)
03-13	Frequency Detection Level
Range	【0.00~650.00】 Hz
03-14	Frequency Detection Width
Range	【0.00~30.00】 Hz

Output relay RY1. function descriptions:

- 1) 03-11 = **[0]** . RY1 will be ON with Run signal.
- 2) 03-11 = **[1]** . RY1 will be ON with inverter Faults.
- 3) 03-11 = **[2]** . RY1 will be ON when Output Frequency reached Setting Frequency.

When Output Freq. = Setting Frequency - Frequency Detection Width (03-14), Relay Output will be ON.

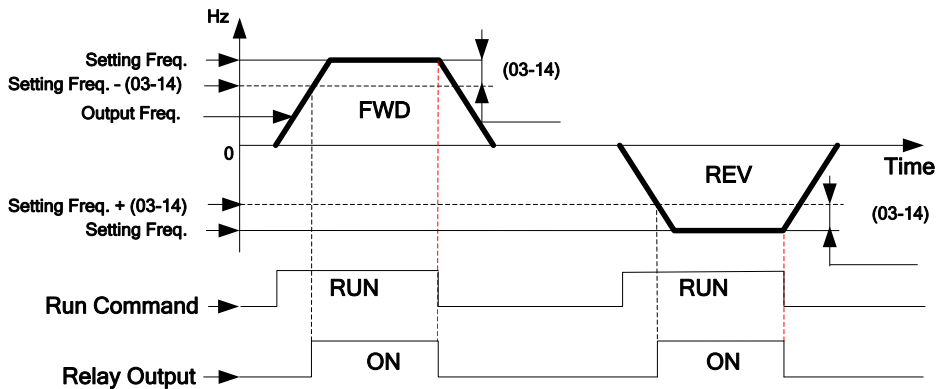

Example : Setting Freq. =30, and Frequency Detection Width (03-14) =5,
Relay will be ON when output frequency reached 25Hz to 30Hz and Run Command is on (Allowable tolerance ±0.01).

- 4) 03-11= **[3]** RY1 will be ON when Setting Freq. and Output Frequency reached (03-13 +/- 03-14).

When Frequency Detection Range Lower Limit < Setting Freq. < Frequency Detection Range Upper Limit
And, Frequency Detection Range Lower Limit < Output Freq. < Frequency Detection Range Upper Limit
Relay output will be ON! Allowable tolerance ±0.01!

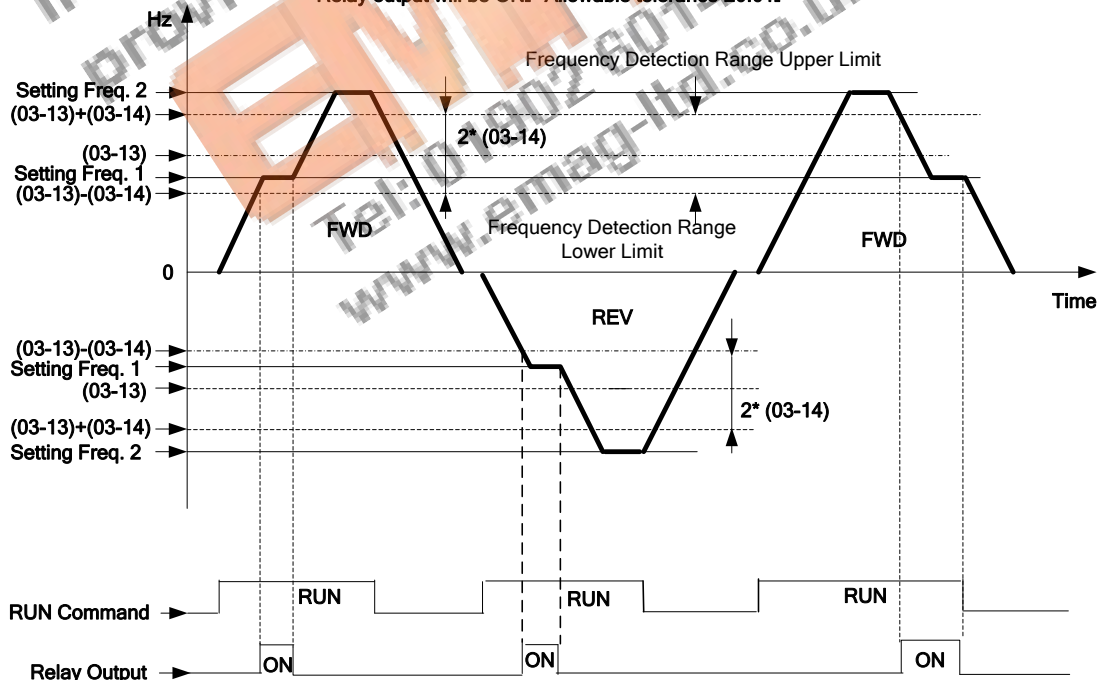

Example: Frequency Detection Level (03-13) =30, and Frequency Detection Width (03-14) =5 cause Frequency Detection Range upper limit = 35, and Frequency Detection Range lower limit = 25. So RY1 will be on when Setting Freq. and Output Freq. are both under these limits; on the other hand, RY1 will be off when Setting Freq. and Output Freq. are not under these limits either.

5) 03-11= **【4】** . RY1 will be on while Output Freq. > Frequency Detection Level (03-13).

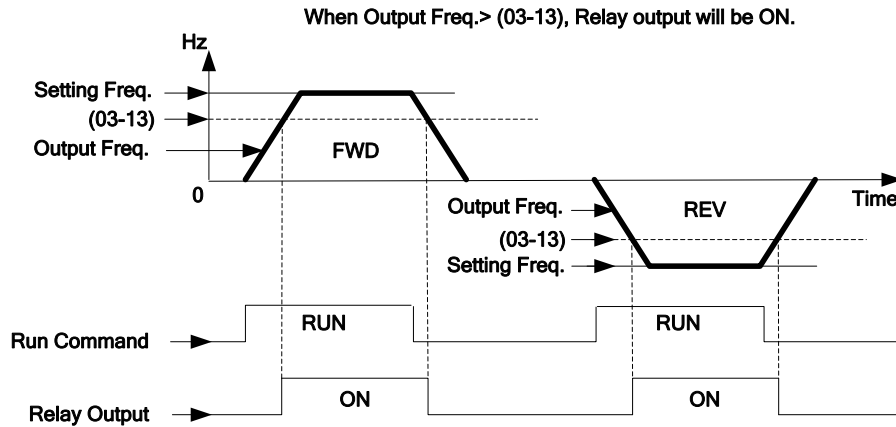

6) 03-11= **【5】** . RY1 will be on while Output Freq. < Frequency Detection Level (03-13).

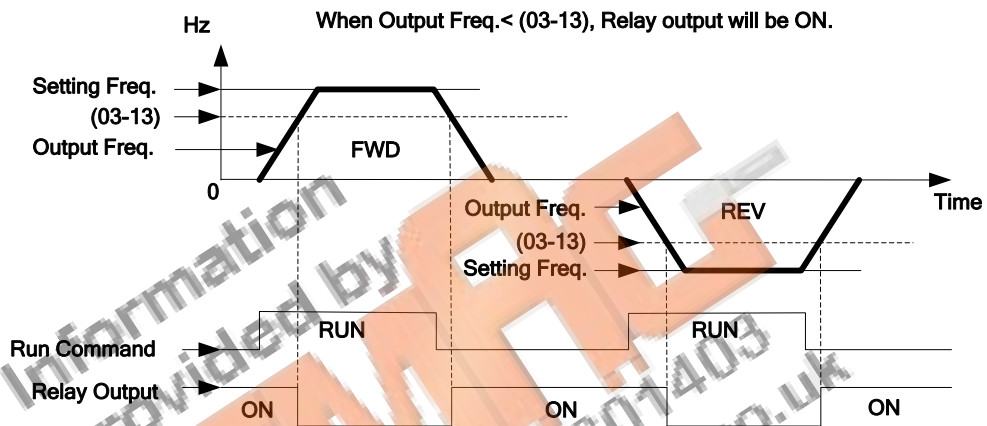

03-15	Output Current Detection Level
Range	【0.1~15.0】 A
03-16	Output Current Detection Period
Range	【0.1~10.0】 Sec

- 03-11= **【13】** .RY1 will be on as soon as the output current value > Output current detection level (03-15).
- 03-15: Setting range (0.1~15.0 Amps) as required according to the rated motor current.
- 03-16: Setting range (0.1~10.0) unit: seconds.

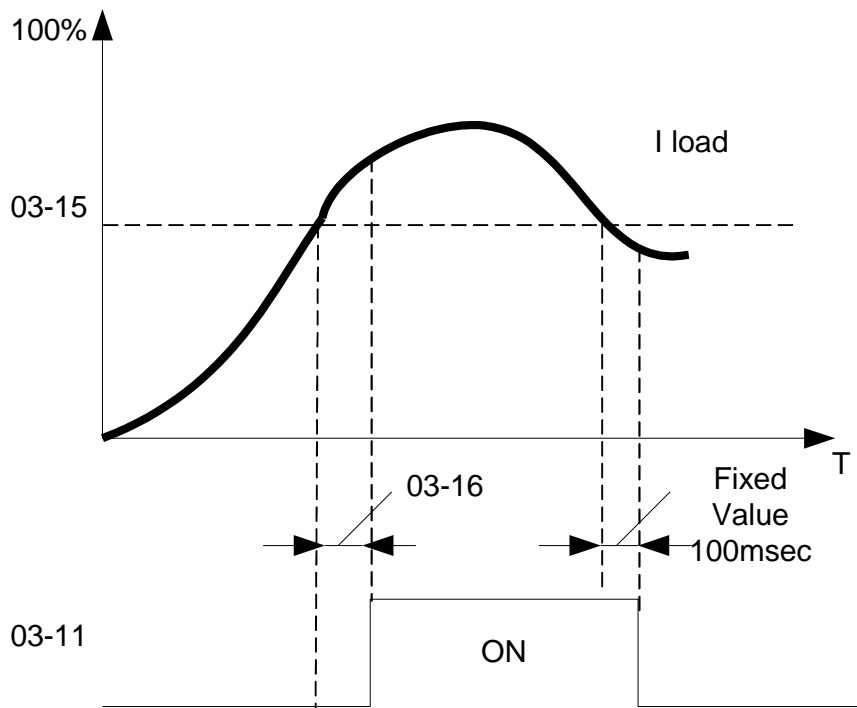

03-17	Brake Release Level
Range	【0.00~20.00】 Hz
03-18	Brake Engage Level
Range	【0.00~20.00】 Hz

- If 03-11 = **【14】**
- In accelerating mode, RY1 will be ON as soon as the actual output frequency reaches the external Brake release level set in parameter 03-17.
- In decelerating mode, RY1 will be OFF as soon as the actual output frequency reaches the external Brake engage level set in parameter 03-18.

Timing diagram for 03-17 < 03-18 is shown below:

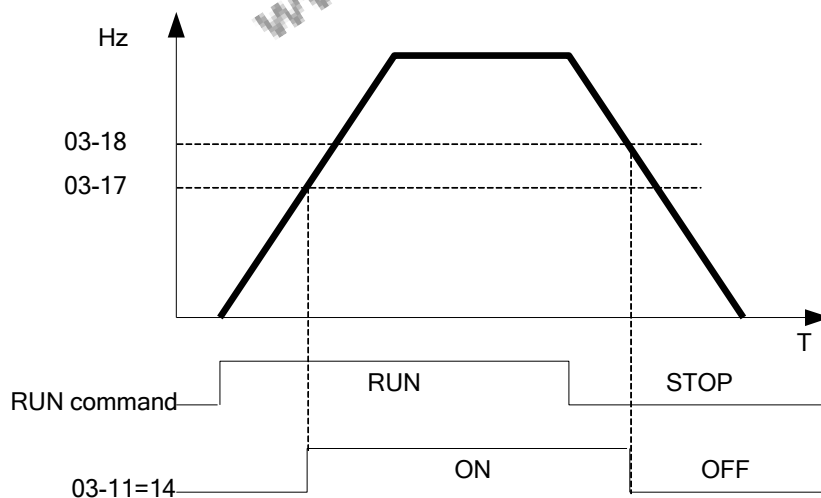

Timing diagram for 03-17 > 03-18 is shown below:

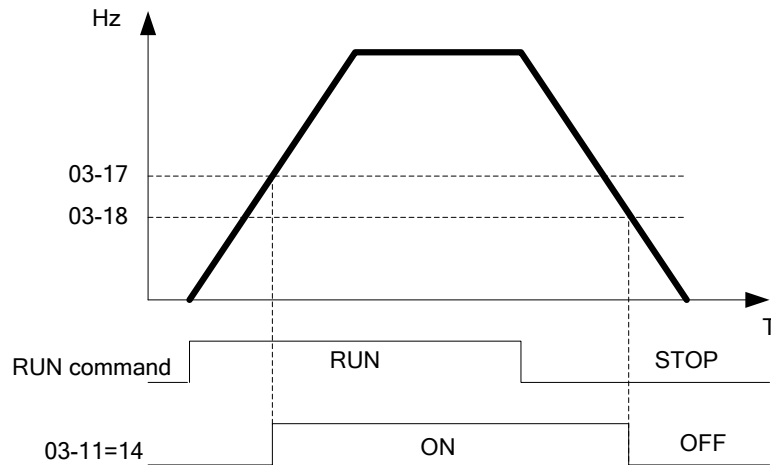

03- 19	Relay Output Status type
Range	【0】 :A (Normally open) 【1】 :B (Normally close)

04- External analog signal input / output functions

04- 00	Analog Voltage & Current input selections										
Range	<table style="width: 100%; border: none;"> <tr> <td style="text-align: center;">AVI</td> <td style="text-align: center;">ACI</td> </tr> <tr> <td>【0】 :0~10V</td> <td>0~20mA</td> </tr> <tr> <td>【1】 :0~10V</td> <td>4~20mA</td> </tr> <tr> <td>【2】 :2~10V</td> <td>0~20mA</td> </tr> <tr> <td>【3】 :2~10V</td> <td>4~20mA</td> </tr> </table>	AVI	ACI	【0】 :0~10V	0~20mA	【1】 :0~10V	4~20mA	【2】 :2~10V	0~20mA	【3】 :2~10V	4~20mA
AVI	ACI										
【0】 :0~10V	0~20mA										
【1】 :0~10V	4~20mA										
【2】 :2~10V	0~20mA										
【3】 :2~10V	4~20mA										

➤ **Analog Input Scaling formulas:-**

- AVI (0~10V), ACI (0~20mA)

$$\text{AVI}(0\sim 10\text{V}): F(\text{Hz}) = \frac{V(\text{v})}{10(\text{v})} \times (00 - 12) ;$$

$$\text{ACI}(0\sim 20\text{mA}): F(\text{Hz}) = \frac{I(\text{mA})}{20(\text{mA})} \times (00 - 12)$$

- AVI (2~10V), ACI (4~20mA)

$$\text{AVI}(2\sim 10\text{V}): F(\text{Hz}) = \frac{V - 2(\text{v})}{10 - 2(\text{v})} \times (00 - 12), V \geq 2;$$

$$\text{ACI}(4\sim 20\text{mA}): F(\text{Hz}) = \frac{I - 4(\text{mA})}{20 - 4(\text{mA})} \times (00 - 12), I \geq 4;$$

04- 01	AVI signal verification Scan Time
Range	【1~200】 1m s
04- 02	AVI Gain
Range	【0 ~ 1000】 %
04- 03	AVI Bias
Range	【0~ 100】 %
04- 04	AVI Bias Selection
Range	【0】 : Positive 【1】 : Negative
04- 05	AVI Slope
Range	【0】 : Positive 【1】 : Negative
04- 06	ACI signal verification Scan Time
Range	【1~200】 1m sec
04- 07	ACIGain
Range	【0 ~ 1000】 %
04- 08	ACI Bias
Range	【0 ~ 100】 %
04- 09	ACI Bias Selection
Range	【0】 : Positive 【1】 : Negative
04-10	ACI Slope
Range	【0】 : Positive 【1】 : Negative

- Set 04- 01 and 04- 06 for Analog signal verification. Inverter reads the average values of A/D signal once per (04- 01/04- 06 x 1ms). Set scan intervals according to the application and with consideration for signal instability or interference effects on the signal by external sources. Long scan times will result in slower response time.

AVI. Analog Voltage input scaling examples by adjusting Gain, Bias & Slope parameters (04-02~04-05).

(1) Positive Bias type (04-04= 0) and effects of modifying Bias amount by parameter 04-03 and Slope type with parameter 04-05 are shown in Fig 1&2.

Figure 1.

	04- 02	04- 03	04- 04	04- 05
A	100%	50%	0	0
B	100%	0%	0	0

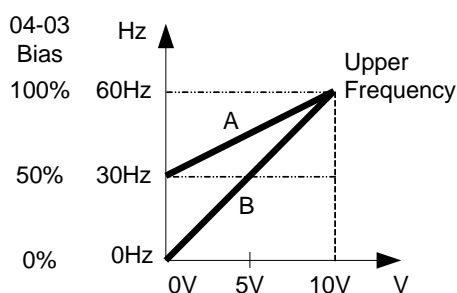
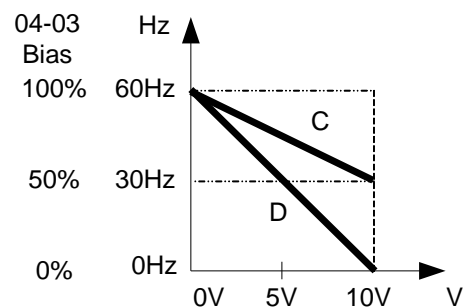

Figure 2.

	04- 02	04- 03	04- 04	04- 05
C	100%	50%	0	1
D	100%	0%	0	1



(2) Negative Bias type and effects of modifying Bias amount by parameter 04-03 and Slope type with parameter 04-05 are shown in Fig 3&4.

Figure3:

	04- 02	04- 03	04- 04	04- 05
E	100%	20%	1	0

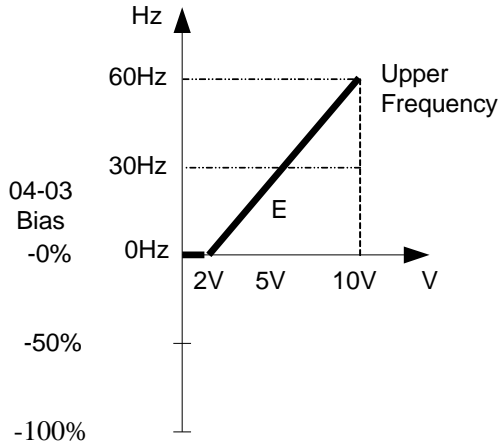
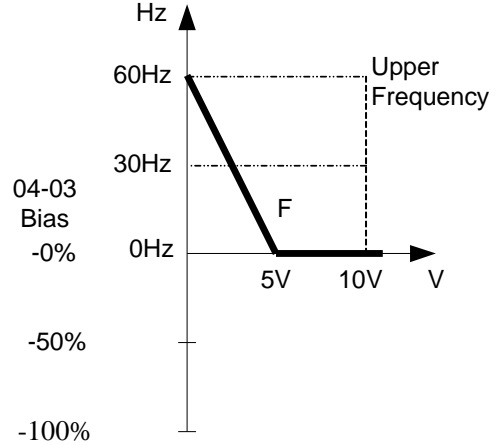

Figure4:

	04- 02	04- 03	04- 04	04- 05
F	100%	50%	1	1



(3) Offset bias set to 0% (04-03) and effect of modifying Analog Gain (04-02), Bias type (04-04) and slope type(04-05) are shown in shown Fig 5&6.

Figure 5

	04- 02	04- 03	04- 04	04- 05
A'	50%	0%	0/1	0
B'	200%	0%	0/1	0

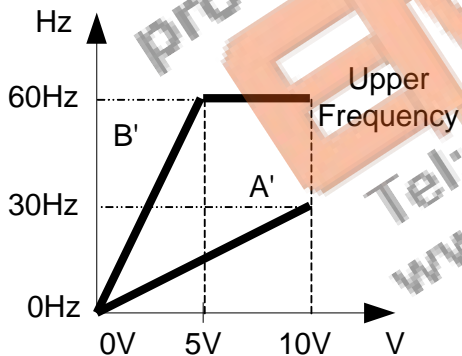
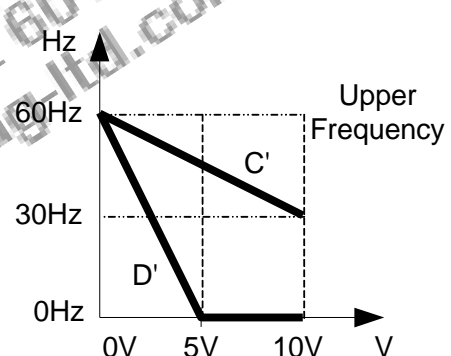

Figure 6

	04- 02	04- 03	04- 04	04- 05
C'	50%	0%	0/1	1
D'	200%	0%	0/1	1



(4) Various other examples of analog input scaling and modification are shown in following figures 7,8,9 & 10.

Figure7

	04- 02	04- 03	04- 04	04- 05
a	50%	50%	0	0
b	200%	50%	0	0

Figure 8

	04- 02	04- 03	04- 04	04- 05
c	50%	50%	0	1
d	200%	50%	0	1

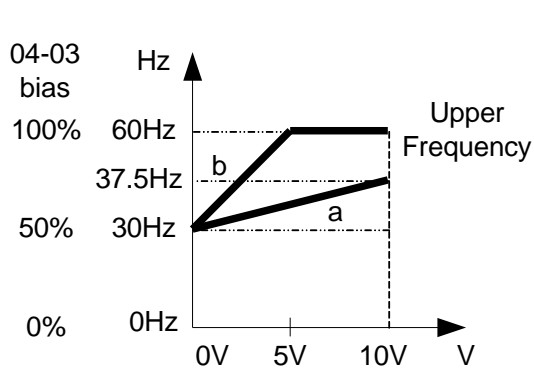

Figure 9

	04- 02	04- 03	04- 04	04- 05
e	50%	20%	1	0
f	200%	20%	1	0

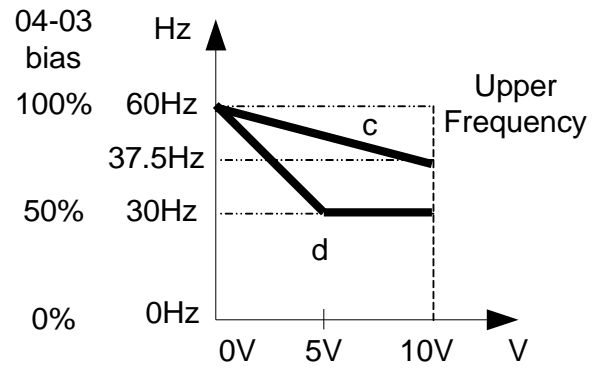
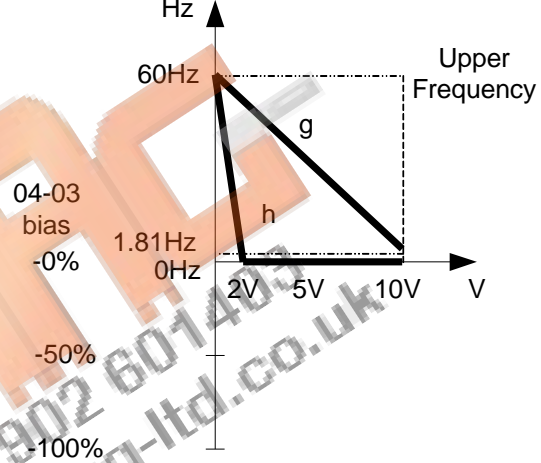
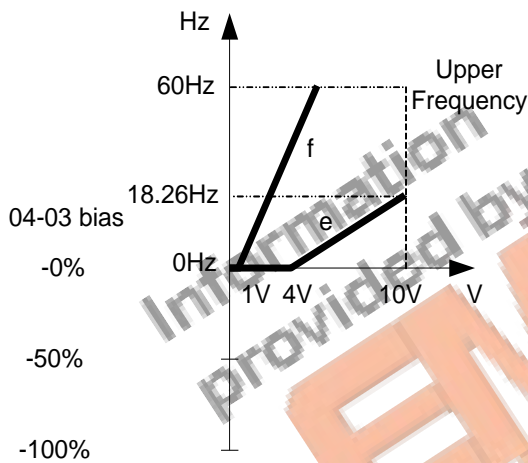

Figure 10

	04- 02	04- 03	04- 04	04- 05
g	50%	50%	1	1
h	200%	0%	0	1



04-11	Analog Output (AO) function selection.
Range	<p>【0】 :Output frequency</p> <p>【1】 :Frequency Setting</p> <p>【2】 :Output voltage</p> <p>【3】 :DC Bus Voltage</p> <p>【4】 :Output current</p>

Example: Set 04-11 required according to the following table.

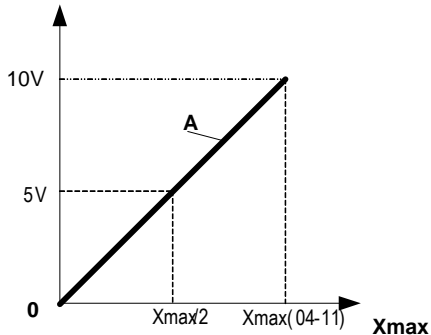

04-11	A	Xmax
【0】	Output frequency	upper frequency limit
【1】	Frequency Setting	upper frequency limit
【2】	Output voltage	Motor Rated Voltage
【3】	DC Bus Voltage	220V: 0~400V
【4】	Output current	2 times rated current of inverter

04-12	AO Gain
Range	【0 ~ 1000】 %
04-13	AO Bias
Range	【0 ~ 100】 %
04-14	AO Bias Selection
Range	【0】 : Positive 【1】 : Negative
04-15	AO Slope
Range	【0】 : Positive 【1】 : Negative

- Select the Analog output type for the multifunction analog output on terminal (TM2) as required by parameter 04-11. Output format is 0-10V dc. The output voltage level can be scaled and modified by parameters 04-12 to 04-15 if necessary.
- The modification format will be same as the examples shown previously for Analog Voltage Input (AVI) parameters 4-02 to 4-05.

Note: the max output voltage is 10V due to the hardware of the circuit.
Use external devices that require a maximum of 10V dc signal.

05- Preset Frequency Selections.

05- 00	Preset Speed Control mode Selection
Range	【0】 : Common Accel / Decel. 【1】 : Individual Accel/Decel for each preset speed 0-7.

05- 01	Preset Speed 0 (Keypad Freq)
05- 02	Preset Speed 1
05- 03	Preset Speed 2
05- 04	Preset Speed 3
05- 05	Preset Speed 4
05- 06	Preset Speed 5
05- 07	Preset Speed 6
05- 08	Preset Speed 7
Range	【0.00 ~ 650.00】 Hz
05-17	Preset Speed 0 Acceleration time
05-18	Preset Speed 0 Deceleration time
05-19	Preset Speed 1 Acceleration time
05- 20	Preset Speed 1 Deceleration time
05- 21	Preset Speed 2 Acceleration time
05- 22	Preset Speed 2 Deceleration time
05- 23	Preset Speed 3 Acceleration time
05- 24	Preset Speed 3 Deceleration time
05- 25	Preset Speed 4 Acceleration time
05- 26	Preset Speed 4 Deceleration time
05- 27	Preset Speed 5 Acceleration time

05- 28	Preset Speed 5 Deceleration time
05- 29	Preset Speed 6 Acceleration time
05- 30	Preset Speed 6 Deceleration time
05- 31	Preset Speed 7 Acceleration time
05- 32	Preset Speed 7 Deceleration time
Range	【0.1 ~ 3600.0】 s

- When 05- 00 = **【0】** Accel /Decl 1 or 2 set by parameters 00-14/00-15 or 00-16/00-17 apply to all speeds.
- When 05- 00 = **【1】** Individual Accel/Decel apply to each preset speed 0-7. Parameters 05-17 to 05-32.
- Formula for calculating acceleration and deceleration time:

$$\text{Actual Acc time} = \frac{\text{Time of Accel1 or 2 x Preset Frequency}}{\text{Max Frequency}}$$

$$\text{Actual Dec time} = \frac{\text{Time of Accel1 or 2 x Preset Frequency}}{\text{Max Frequency}}$$

- Maximum output frequency = parameter 01-02 when programmable V/F is selected by 01- 00= **【7】** .
- Maximum output frequency = 50.00 hz or 60.00 hz when preset V/F patterns are selected. 01-00≠ **【7】** .

Example : 01- 00= **【7】** , 01- 02= **【50】** Hz, 05- 02= **【10】** Hz (preset speed1),
05-19= **【5】** s(Accel time), 05-20= **【20】** s (Decel time)

$$\text{Preset speed 1 Actual Accel time} = \frac{(05-19) \times 10(\text{Hz})}{01-02} = 1(\text{s})$$

$$\text{Preset speed 1 Actual Deccel time} = \frac{(05-20) \times 10(\text{Hz})}{01-02} = 4(\text{s})$$

- **Multi speed run/stop cycles with Individual accel/decal times. 05-00= **【1】****
- Two modes are shown below:-
- Mode1 = On/Off run command
- Mode2= Continuous run command

Mode1 Example: 00- 02= **【1】** (External Run/Stop Control).

00- 04= **【1】** (Operation Mode : Run/stop-forward/reverse).

S1: 03- 00= **【0】** (RUN/STOP);

S2: 03- 01= **【1】** (Forward/Reverse);

S3: 03- 02= **【2】** (Preset speed 1);

S4: 03- 03= **【3】** (Preset speed 2);

S5: 03- 04= **【4】** (Preset speed 4);

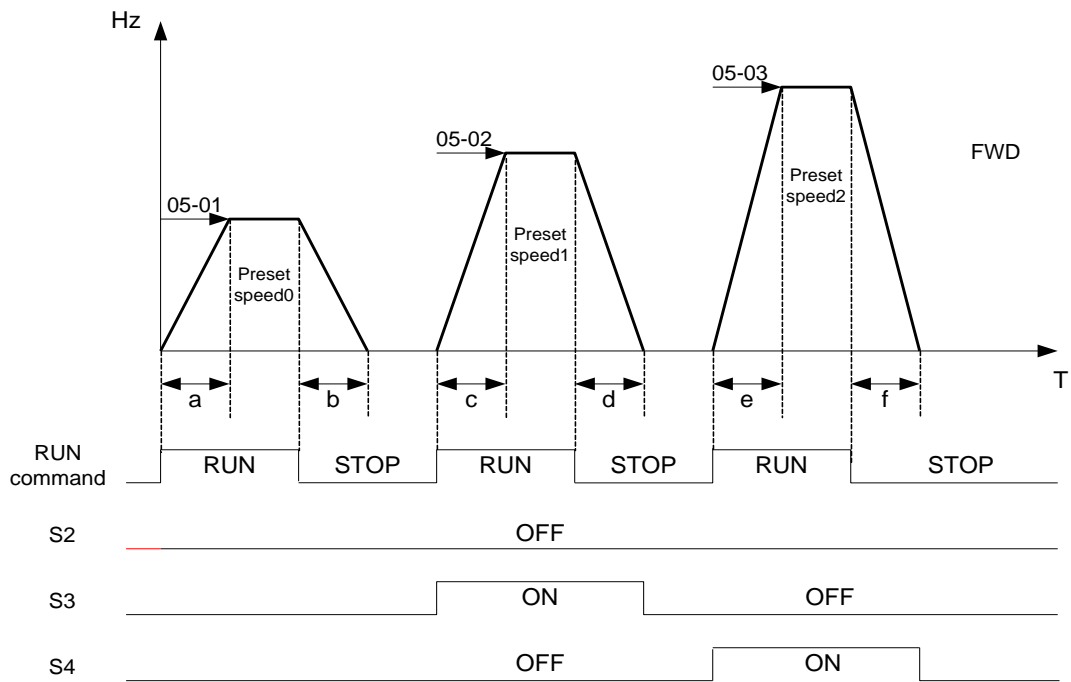

When the run command is On/Off, acceleration and deceleration times for each cycle can be calculated as below:- time unit is in seconds'

$$a = \frac{(05-17) \times (05-01)}{01-02}, b = \frac{(05-18) \times (05-01)}{01-02}, c = \frac{(05-19) \times (05-02)}{01-02}, d = \frac{(05-20) \times (05-02)}{01-02} \dots$$

- **Mode2 Example.** Continuous run command.
- Set S1 for Continuous Run
- Set S2 For Forward /Reverse direction selection
- Set multi function terminals S3,S4 & S5 for setting three different preset speeds

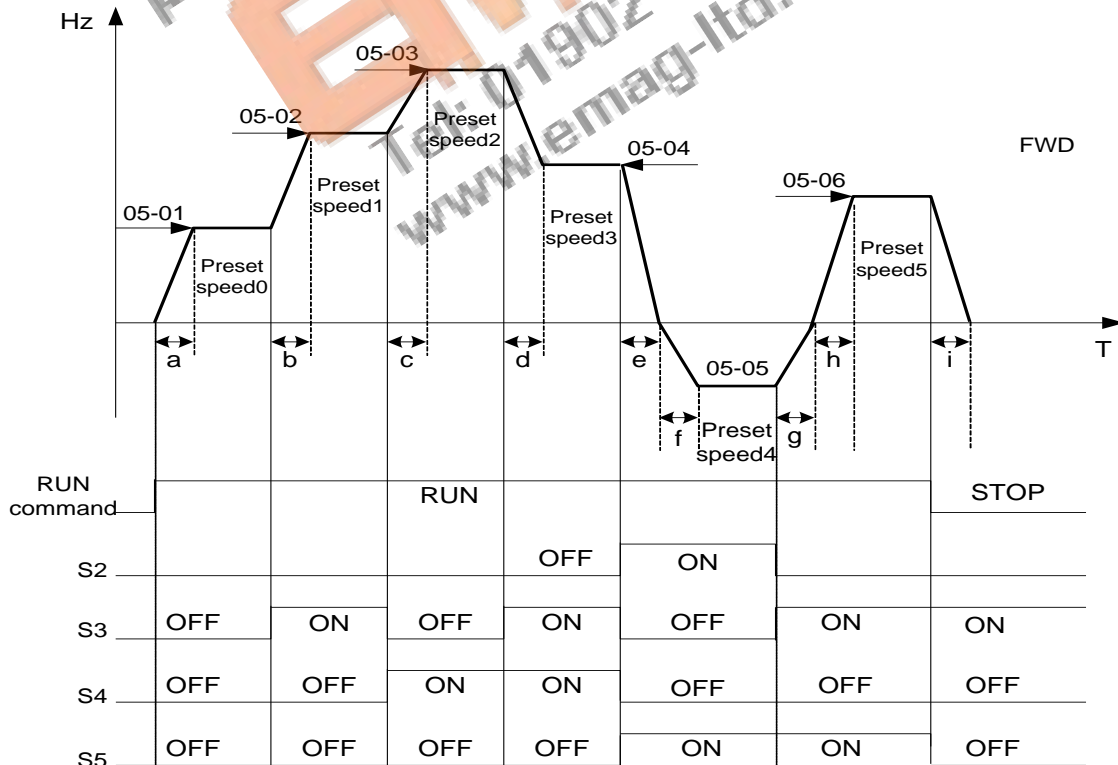

When the run command is continuous, acceleration and deceleration times for each segment can be calculated as below:-

$$\text{Ex] } a = \frac{(05-17) \times (05-01)}{01-02}, b = \frac{(05-19) \times [(05-02) - (05-01)]}{01-02}$$

$$c = \frac{(05-21) \times [(05-03) - (05-02)]}{01-02}, d = \frac{(05-24) \times [(05-03) - (05-04)]}{01-02}$$

$$e = \frac{(05-26) \times (05-05)}{01-02}, f = \frac{(05-28) \times (05-05)}{01-02}, g = \frac{(05-27) \times (05-05)}{01-02}$$

$$h = \frac{(05-29) \times (05-05)}{01-02}, i = \frac{(05-32) \times (05-05)}{01-02} \dots \text{Unit(sec)}$$

06- Auto Run(Auto Sequencer) function

06- 00	Auto Run(sequencer) mode selection
Range	<p>【0】 :Disabled</p> <p>【1】 :Single cycle (Continues to run from the unfinished step if restarted).</p> <p>【2】 :Periodic cycle. (Continues to run from the unfinished step if restarted).</p> <p>【3】 :Single cycle, then holds the speed of final step to run. (Continues to run from the unfinished step if restarted).</p> <p>【4】 :Single cycle. (Starts a new cycle if restarted).</p> <p>【5】 :Periodic cycle. (Starts a new cycle if restarted).</p> <p>【6】 :Single cycle, then hold the speed of final step to run. (Starts a new cycle if restarted).</p>

Frequency of the step 0 is set by parameter 05-01 keypad Frequency.

06- 01	Auto _ Run Mode Frequency Command 1
06- 02	Auto _ Run Mode Frequency Command 2
06- 03	Auto _ Run Mode Frequency Command 3
06- 04	Auto _ Run Mode Frequency Command 4
06- 05	Auto _ Run Mode Frequency Command 5
06- 06	Auto _ Run Mode Frequency Command 6
06- 07	Auto _ Run Mode Frequency Command 7
Range	【0.00 ~ 650.00】 Hz

06- 16	Auto_ Run Mode Running Time Setting0
06- 17	Auto_ Run Mode Running Time Setting1
06- 18	Auto_ Run Mode Running Time Setting2
06- 19	Auto_ Run Mode Running Time Setting3
06- 20	Auto_ Run Mode Running Time Setting4
06- 21	Auto_ Run Mode Running Time Setting5
06- 22	Auto_ Run Mode Running Time Setting6
06- 23	Auto_ Run Mode Running Time Setting7
Range	【0.00 ~ 3600.0】 Sec

06- 32	Auto_ Run Mode Running Direction0
06- 33	Auto_ Run Mode Running Direction1

06- 34	Auto_ Run Mode Running Direction2
06- 35	Auto_ Run Mode Running Direction3
06- 36	Auto_ Run Mode Running Direction4
06- 37	Auto_ Run Mode Running Direction5
06- 38	Auto_ Run Mode Running Direction6
06- 39	Auto_ Run Mode Running Direction7
Range	【0】 : STOP 【1】 : Forward 【2】 : Reverse

- Auto Run sequencer mode has to be enabled by using one of the multifunctional inputs S1 to S5 and setting the relevant parameter 03-00 to 03-04 to selection **【18】** .
- Various Auto Run (sequencer) modes can be selected by parameter (06-00) as listed above.
- 7 Auto Run (sequencer) modes can be selected by parameters (06-01~06-39)
- Auto Run frequency commands1 to 7 are set with Parameters (06-01 ~ 06-07),
- Sequence run times are set with parameters (06-17 ~ 06-23)
- FWD/REV Direction for each sequence can be set with parameters (06-33 ~ 06-39).
- Auto sequence 0, frequency is set from keypad by parameter 05-01, sequence run time and direction are set by parameters 06-16 and 06-32.

Auto RUN (Auto Sequencer) examples are shown in the following pages:-

Example 1. Single Cycle (06- 00=1,4)

The inverter will run for a single full cycle based on the specified number of sequences, then it will stop. In this example 4 sequences are set, three in forward direction and one in Reverse.

Auto Run Mode. 06- 00= **【1】** or **【4】** ,

Frequency 05- 01= **【15】** Hz, 06- 01= **【30】** Hz, 06- 02= **【50】** Hz, 06- 03= **【20】** Hz

Sequence Run Time 06-16= **【20】** s, 06-17 = **【25】** s, 06-18= **【30】** s, 06-19= **【40】** s ,

Direction 06-32= **【1】** FWD, 06-33 = **【1】** FWD, 06-34= **【1】** (FWD), 06-35= **【2】** (REV)

Unused Sequence Parameters 06-04~ 06-07= **【0】** Hz , 06-20~06-23= **【0】** s , 06-36~06-39= **【0】**

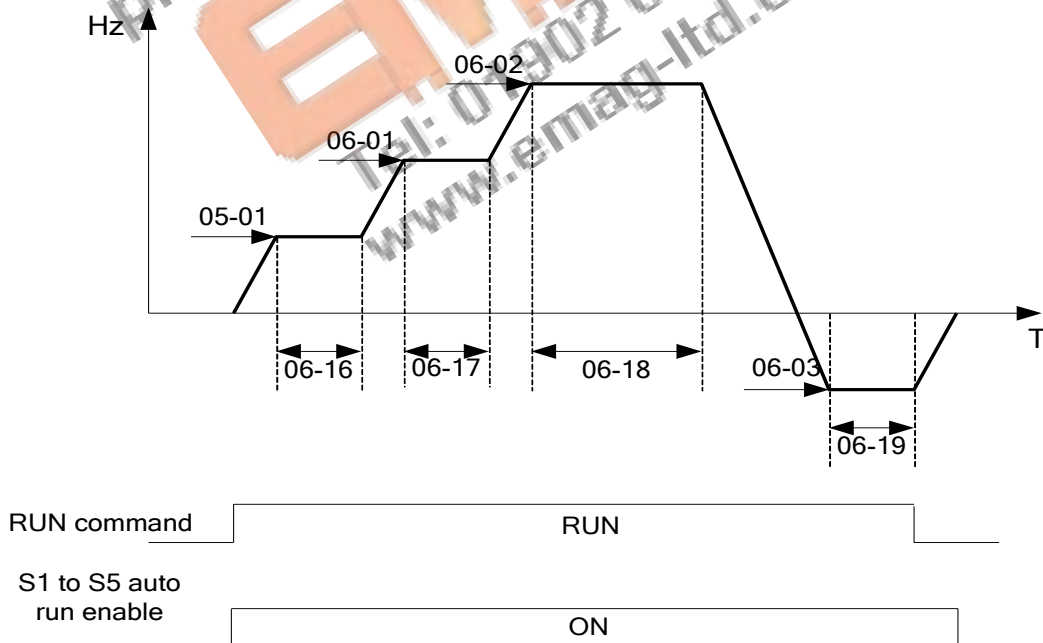

Example 2. Periodic cycle Run.

Mode: 06- 00= **[2]** or **[5]**

The inverter will repeat the same cycle periodically.

All other Parameters are set same as Example 1. shown above.

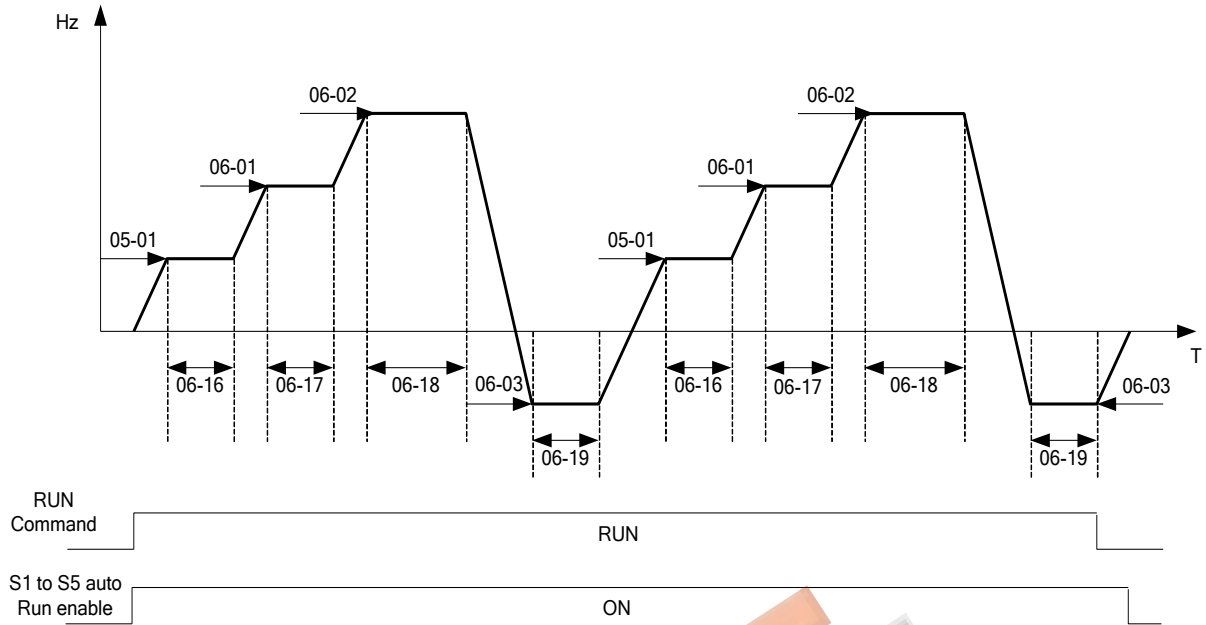

Example 3. Auto_Run Mode for Single Cycle 06-00= [3 or 6]

The speed of final step will be held to run.

Auto Run Mode. 06- 00 = **[3]** or **[6]**

Frequency 05- 01 = **[15]** Hz, 06- 01= **[30]** Hz, 06- 02= **[50]** Hz, 06- 07= **[20]** Hz,

Sequence Run Time 06-16 = **[20]** s, 06-17= **[25]** s, 06-18= **[30]** s, 06-23= **[40]** s,

Direction 06-32 = **[1]** FWD 06-33= **[1]** , 06-34 = **[1]** , 06-39= **[1]** ,

Unused Sequence Parameters 06-03~06-06= **[0]** Hz, 06-19~06-22= **[0]** s, 06-35~06-38 = **[0]**

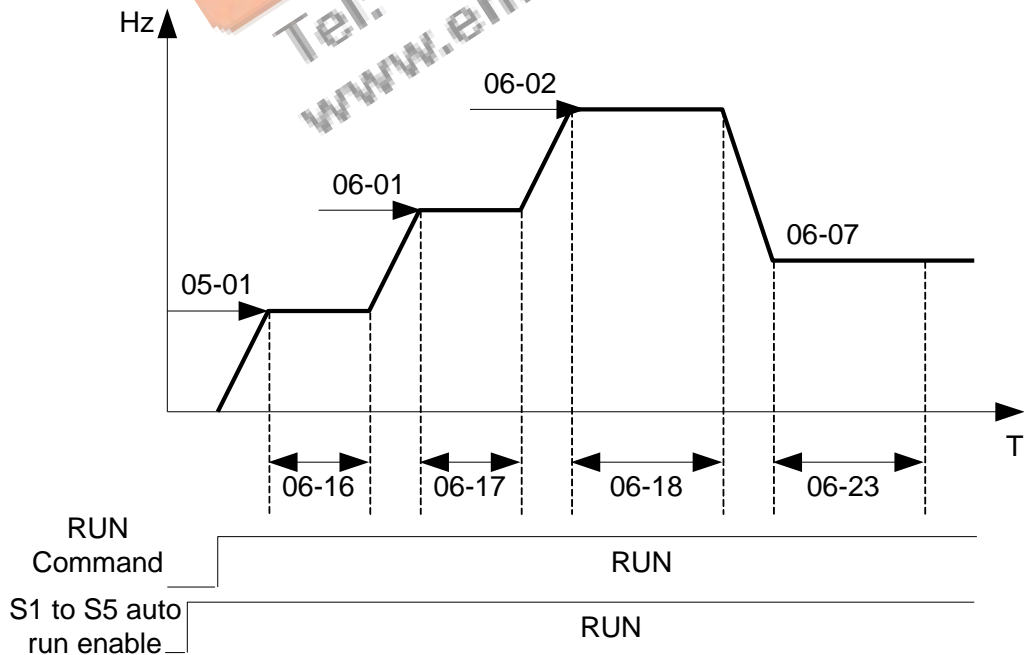

Example 4&5 .

Auto Run Mode 06-00= 【1~3】 . After a restart continues to run from the unfinished step.

Auto Run Mode 06-00= 【4~6】 . After a restart, it will begin a new cycle.

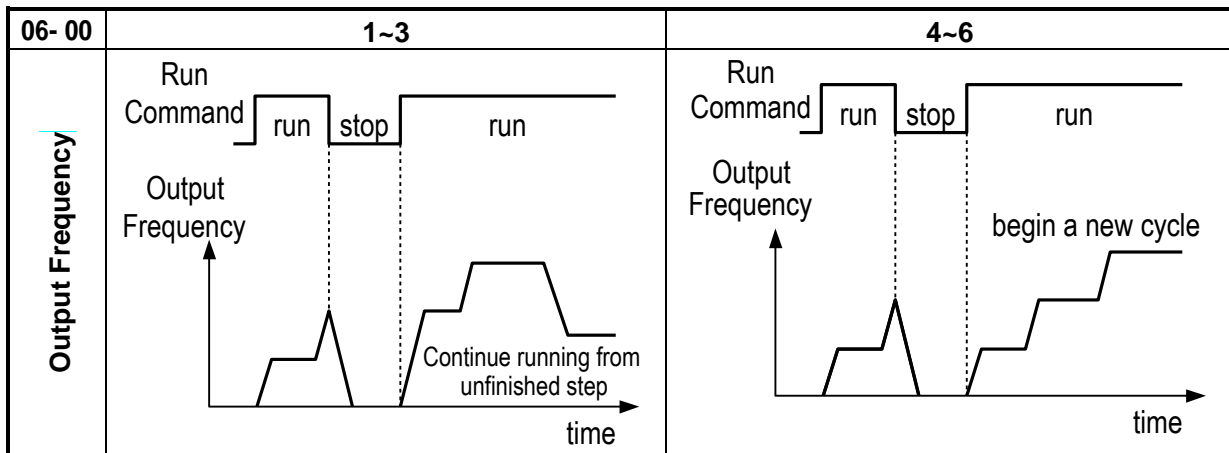

- ACC/DEC time in Auto run mode will be according to the setting of 00-14/00-15 or 00-16/00-17.
- For Auto sequence 0.The run frequency will be according to keypad frequency set by parameter 05-01.Parameters 06-16 and 06-32 are used to set the sequence Run time and Run direction.

07- Start/Stop command setup	
07- 00	Momentary power loss and restart
Range	【0】 :Momentary Power Loss and Restart disable 【1】 :Momentary power loss and restart enable

- If the input power supply due to sudden increase in supply demand by other equipment results in voltage drops below the under voltage level, the inverter will stop its output at once.
- When 07-00 = **【0】** .On power loss, the inverter will not start.
- When 07-00 = **【1】** .After a momentary power loss, inverter will restart with the same frequency before power loss, and there is no limitation on number of restarts.
- On power loss, as long as the inverter CPU power is not completely lost, the momentary power loss restart will be effective, restart will be according to setting of parameters 00-02 & 07-04 and status of External run switch.

Caution:- After any power loss if the Run mode is set to External by parameter 00-02=1 and if Direct start on power up is also selected by parameter 07-04=0, please note that the inverter will run on resumption of power.

To ensure safety of operators and to avoid any damages to the machinery, all necessary safety measure must be considered, including disconnection of power to the inverter.

07- 01	Auto Restart Delay Time
Range	【0.0~800.0】 Sec
07- 02	Number of Auto Restart Attempts
Range	【0~10】

- 07- 02= **【0】** : The inverter will not auto restart after trips due to fault.
- 07- 02> **【0】** , 07- 01= **【0】** .After a trip due to fault the inverter will run with the same frequency before power loss, and restarts after an internal delay of 0.5 seconds.

- 07- 02> **[0]** , 07- 01> **[0]** , After a fault trip the inverter will run with the same frequency before power loss, and restart with a delay according the preset in parameter 07-01.
- **Note:- Auto restart after a fault will not function while DC injection braking or decelerating to stop**

07- 03	Reset Mode Setting
Range	[0] :Enable Reset Only when Run Command is Off [1] :Enable Reset when Run Command is On or Off

- 07-03=0 Once the inverter is detected a fault, please turn Run switch Off and then On again to perform reset, otherwise restarting will not be possible.

07- 04	Direct Running on Power Up
Range	[0] :Enable Direct running after power up [1] :Disable Direct running after power up
07- 05	Delay-ON Timer (Seconds)
Range	[1.0~300.0] Sec

- When direct run on power up is selected by 07-04=0 and the inverter is set to external run by (00-02/00-03=1), if the run switch is ON as power is applied, the inverter will auto start. It is recommend that the power is turned off and the run switch is also off to avoid possibility of injury to operators and damage to machines as the power is reapplied.

Note: If this mode is required all safety measures must be considered including warning labels.

- When direct run on power up is disabled by 07-04=1 and if the inverter is set to external run by (00-02/00-03=1), if the run switch is ON as power is applied, the inverter will not auto start and the display will flash with STP1. It will be necessary to turn OFF the run switch and then ON again to start normally.

07- 06	DC Injection Brake Start Frequency (Hz)
Range	[0.10 ~ 10.00] Hz
07- 07	DC Injection Brake Level (%)
Range	[0~ 20] %
07- 08	DC Injection Brake Time (Sec)
Range	[0.0 ~ 25.5] Sec

- 07- 08/07- 06 set the DC injection brake duration and the brake start frequency as shown below.

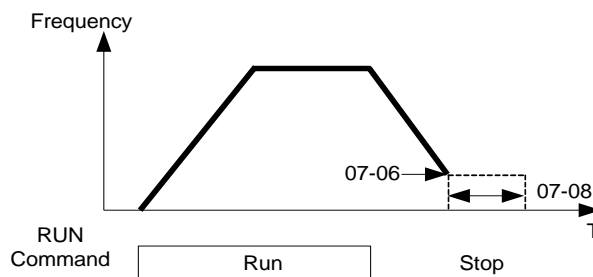

07- 09	Stopping Method
Range	[0] :Deceleration to stop. [1] :Coast to stop.

- 07- 09 = **[0]** : after receiving stop command, the motor will decelerate to stop according to setting of 00-15, deceleration time 1.
- 07- 09 = **[1]** : after receiving stop command, the motor will free-run (Coast) to stop.

08- Protection function group	
08- 00	Trip Prevention Selection
Range	【xxxx0】 :Enable Trip Prevention During Acceleration 【xxxx1】 :Disable Trip Prevention During Acceleration 【xxx0x】 :Enable Trip Prevention During Deceleration 【xxx1x】 :Disable Trip Prevention During Deceleration 【xx0xx】 :Enable Trip Prevention in Run Mode 【xx1xx】 :Disable Trip Prevention in Run Mode 【x0xxx】 :Enable over voltage Prevention in Run Mode 【x1xxx】 :Disable over voltage Prevention in Run Mode

08- 01	Trip Prevention Level During Acceleration
Range	【50 ~ 200】 %

- Trip prevention adjustment level during acceleration to prevent over current (OC-A) trips.
- If trip prevention during acceleration is enabled and an over current occurs due to the load, then the acceleration is interrupted until the over current level is dropped below the setting in 08-01 then the acceleration is resumed.

08- 02	Trip Prevention Level During Deceleration
Range	【50 ~ 200】 %

- Trip prevention adjustment level during deceleration to prevent over Voltage (OV-C) trips.
- If trip prevention during deceleration is enabled and an over voltage occurs during stopping due to the load, then the deceleration is interrupted until the over voltage level is dropped below the setting in 08-02 then the deceleration is resumed.

08- 03	Trip Prevention Level during continuous Run Mode
Range	【50 ~ 200】 %

- Trip prevention adjustment level during continuous Run to prevent over current (OC-C) trips.
- If trip prevention during continuous Run is enabled and an over current occurs due the load such as a sudden transient load, then the output frequency is reduced by decelerating to a lower speed until the over current level is dropped below the preset in 08-03, then the output frequency accelerates back to the normal running frequency.

08- 04	Over voltage Prevention Level during Run Mode
Range	200: 【350~390】 VDC 400: 【700~780】 VDC

- Over voltage prevention level can be set by parameter 08-04 when necessary.
When the DC bus voltage is higher than the level set in 08-04, the over voltage fault will occur.

08- 05	Electronic Motor Overload Protection Operation Mod (OL1)
Range	【0】 :Disable Electronic Motor Overload Protection 【1】 :Enable Electronic Motor Overload Protection

08- 06	Operation After Overload Protection is Activated
Range	【0】 :Coast-to-Stop After Overload Protection is Activated 【1】 :Drive Will Not Trip when Overload Protection is Activated (OL1)

- 08- 06 = **【0】** : On overload condition the inverter coast to stop as the thermal relay detects the overload and the display will flash OL1.To reset Press the 'Reset' key or use an external reset to

continue to run.

- 08-06 = **【1】** : On overload condition the inverter continues to run, display flash with OL1, until the current falls below the overload level.

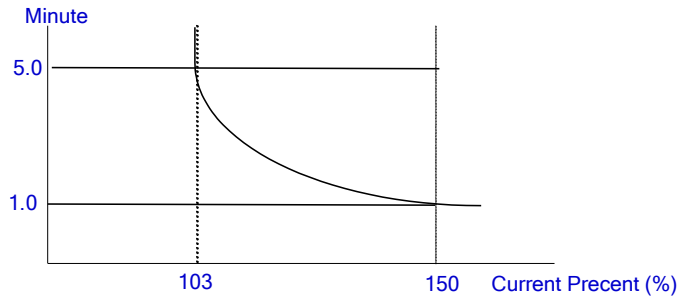

08-07	OH over heat Protection
Range	【0】 :Auto (Depends on heat sink temp.) 【1】 :Operate while in RUN mode 【2】 :Always Run 【3】 :Disabled

- 08-07= **【0】** : Cooling fan runs as the inverter detects temperature rise.
- 08-07= **【1】** : Cooling fan runs while the inverter is running.
- 08-07= **【2】** : Cooling fan runs continuously.
- 08-07= **【3】** : Cooling fan is Disabled.

08-08	AVR function
Range	【0】 :AVR function enable 【1】 :AVR function disable 【2】 :AVR function disable for stop 【3】 :AVR function disable for Deceleration 【4】 :AVR function disabled for stop & Deceleration from one speed to another speed. 【5】 :when VDC>(360V/740V), AVR function is disabled for stop and Deceleration

- Automatic voltage regulator function provides a level of output voltage stability when there is input voltage instability. So when 08-08=0, Input voltage fluctuations will not effect the output voltage.
- 08-08=1. Input voltage fluctuations will cause fluctuations on output voltage.
- 08-08=2. AVR is disabled during stopping to avoid an increase in stopping time.
- 08-08=3. AVR is disabled only during deceleration from one speed to another speed. This will avoid longer than required deceleration time.

08-09	Input phase loss protection
Range	【0】 :Disabled 【1】 :Enabled

When 08-09= **【1】** :On phase loss warning message PF is displayed.

09- Communication function group

09- 00	Assigned Communication Station Number
Range	【1 ~ 32】

- 09-00 sets the communication station number when there are more than one unit on the communication network. Up to 32 Slave units can be controlled from one master controller such as a PLC.

09- 01	RTU code /ASCII code Selection
Range	【0】 :RTU 【1】 :ASCII

09- 02	Baud Rate Setting (bps)
Range	【0】 :4800 【1】 :9600 【2】 :19200 【3】 :38400

09- 03	Stop Bit Selection
Range	【0】 :1 stop bit 【1】 :2 stop bit

09- 04	Parity Selection
Range	【0】 :no parity 【1】 :even parity 【2】 :odd parity

09- 05	Data Format Selection
Range	【0】 :8 bit data 【1】 :7 bit data

- Set 09-01~09-05 to configure communication format before starting communication.

09- 06	Communication time-out detection time
Range	【0.0~25.5】 Sec

09- 07	Communication time-out operation selection
Range	【0】 :Stop in deceleration time 1 and show COT after communication timeout 【1】 :Stop in free run mode and show COT after communication timeout 【2】 :Stop in deceleration time 2 and show COT after communication timeout 【3】 :Keep running and show COT after Communication timeout

- Time-out detection time: 00.0~25.5 seconds; setting 00.0 seconds: disables time-out function.

09- 08	Err6 fault tolerance times
Range	【1~20】

- When communication error time ≥ 09-08 setting, keypad display shows ERR6.

09- 09	Drive Transmit Wait Time
Range	【5~65】 m s

- This parameter is used to set the converter to receive data from the sending date to the beginning of the time.

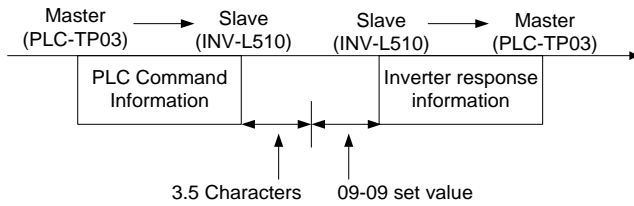

10-PID function Setup

PID block diagram

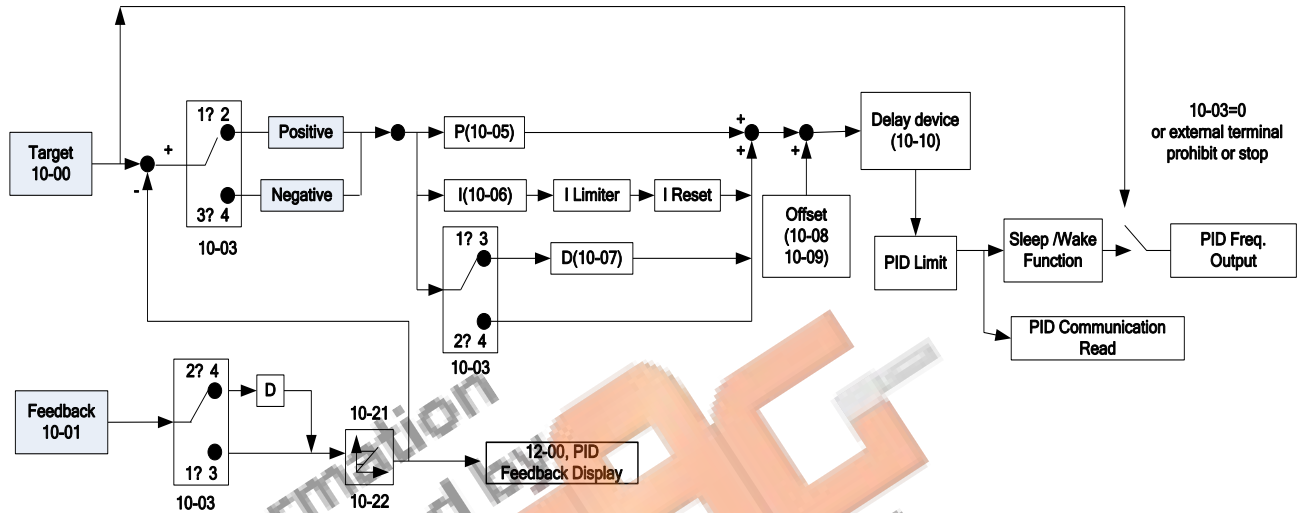

10- 00	PID target value selection
Range	<p>[0] :Potentiometer on Keypad</p> <p>[1] :External AVI Analog Signal Input</p> <p>[2] :External ACI Analog Signal Input</p> <p>[3] :Target Frequency set by Communication method.</p> <p>[4] :Set from keypad by parameter 10-02.</p>

- 10-00 selections are only effective when frequency source selection is set to PID by parameters 00 - 05 \ 00 - 06= 6.

10- 01	PID feedback value selection
Range	<p>[0] :Potentiometer on Keypad</p> <p>[1] :External AVI Analog Signal Input</p> <p>[2] :External ACI Analog Signal Input</p> <p>[3] :Communication setting Frequency</p>

- ! Note: 10-00 and 10-01 can not be set to the same value.

10- 02	PID keypad input
Range	[0.0~100.0] %

10- 03	PID operation selection
Range	【0】 : PID Function disabled 【1】 : FWD Characteristic. Deviation is D-controlled 【2】 : FWD Characteristic. Feedback is D-controlled 【3】 : REV Characteristic. Deviation is D-controlled 【4】 : REV Characteristic. Feedback is D-controlled

➤ 10- 03 = **【1】** .

Deviation (target - detected value) is derivative controlled in unit time set in parameter 10-07.

➤ 10- 03 = **【2】**

Feedback (detected value) is derivative controlled in unit time set in parameter 10- 07.

➤ 10- 03 = **【3】**

Deviation (target value - detected value) is derivative controlled in unit time set in parameter 10-07. If the deviation is positive, the output frequency decreases, vice versa.

➤ 10- 03 = **【4】**

Feed back (detected value) is derivative controlled in unit time set in parameter 10- 07. If the deviation is positive, the output frequency decreases, vice versa.

Note:-

For 10-03 = 1 or 2, If the deviation is positive, the output frequency increases and, vice versa.

For 10-03 = 3 or 4, If the deviation is positive, the output frequency decreases, vice versa.

10- 04	Feedback Gain coefficient
Range	【0.00 ~ 10.00】

➤ 10-04 is the calibration gain. Deviation = set point – (feedback signal×10-04)

10- 05	Proportional Gain
Range	【0.0 ~ 10.0】

➤ 10- 05: Proportion gain for P control.

10- 06	Integral Time
Range	【0.0 ~ 100.0】 s

➤ 10- 06: Integration time for I control

10- 07	Derivative Time
Range	【0.00 ~ 10.00】 s

➤ 10- 07: Differential time for D control

10- 08	PID Offset
Range	【0】 : Positive Direction 【1】 : Negative Direction

10- 09	PID Offset Adjust
Range	【0 ~ 109】 %

➤ 10- 08 /10- 09: Calculated PID output is offset by 10-09 (the polarity of offset is according to10-08)

10-10	PID Output Lag Filter Time
Range	【0.0 ~ 2.5】 s

➤ 10-10: Update time for output frequency.

10-11	Feedback Loss Detection Mode
Range	【0】 :Disable 【1】 :Enable – Drive Continues to Operate After Feedback Loss 【2】 :Enable – Drive “STOPS” After Feedback Loss

- 10-11= **【1】** : On feed back loss detection, continue running, and display ‘PDER’;
- 10-11= **【2】** : On feed back loss detection, stop, and display ‘PDER’.

10-12	Feedback Loss Detection Level
Range	【0 ~ 100】

- 10-12 is the level for signal loss. Error = (Set point – Feedback value). When the error is larger than the loss level setting, the feedback signal is considered lost.

10-13	Feedback Loss Detection Delay Time
Range	【0.0 ~25.5】 s

- 10-13:The minimum time delay before feedback signal loss is determined.

10-14	Integration Limit Value
Range	【0 ~ 109】 %

- 10-14: the Limiter to prevent the PID from saturating.

10-15	Integration Value Resets to Zero when Feedback Signal Equals the target Value
Range	【0】 : Disabled 【1】 : After 1 Sec 【30】 : After 30 Sec (Range:- 1 ~ 30 Sec)

- 10-15=0.As PID feedback value reaches the set point, the integral value will not be reset.
- 10-15=1~30.As PID feedback value reaches the set point, reset to 0 in 1~30 seconds and inverter stops. The inverter will run again when the feedback value differs from the set point value.

10-16	Allowable Integration Error Margin (Unit) (1 Unit = 1/8192)
Range	【0 ~ 100】 %

- 10-16 = 0 ~ 100% unit value: Restart the tolerance after the integrator reset to 0.

10-17	PID Sleep Frequency Level
Range	【0.00~650.00】 Hz

10-18	PID Sleep Function Delay Time
Range	【0.0 ~25.5】 s

10-19	PID Wake up frequency Level
Range	【0.00 ~ 650.00】 Hz

10-20	PID Wake up function Delay Time
Range	【0.0 ~ 25.5】 s

- When PID output frequency is less than the sleep threshold frequency and exceeds the time of sleep delay, the inverter will decelerate to 0 and enters PID sleep mode.
- When PID output frequency is larger than the Wake up threshold frequency inverter will enter the PID mode again as shown in the timing diagram below.

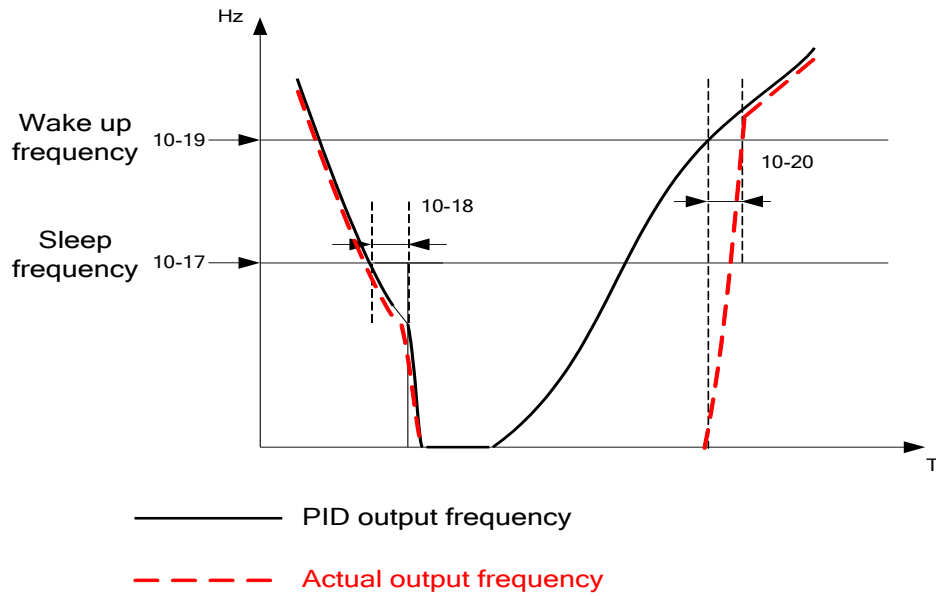

10-21	Max PID Feedback Level.
Range	[0 ~ 999]
10-22	Min PID Feedback Level.
Range	[0 ~ 999]

- Example: If 10-21=100 and 10-22=50 and the unit for the range from 0 to 999 will be defined with the parameters setting of 12-02, actual feedback value variation range, will be scaled to 50 and 100 only for display, as Shown below.

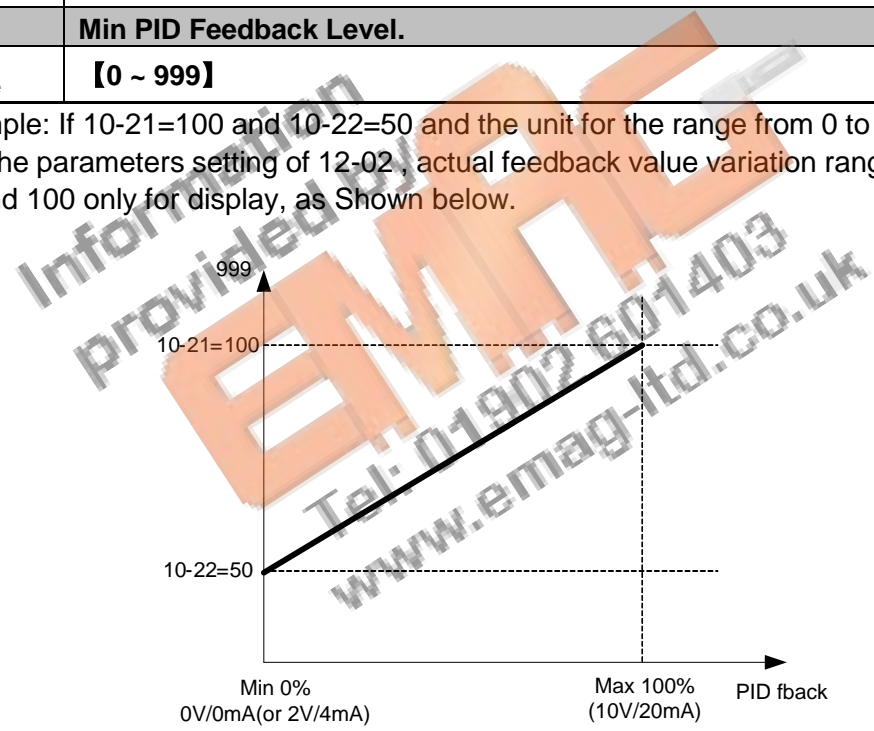

11 Performance control functions

11- 00	Prevention of Reverse operation
Range	【0】 :Reverse command is enabled 【1】 :Reverse command is disabled

- 11-00=1, the reverse command is **disabled**.

11- 01	Carrier Frequency
Range	【1~16】 KHz

11- 02	Carrier mode selection
Range	【0】 :Carrier mode0 3-phase PW M modulation 【1】 :Carrier mode1 2-phase PW M modulation 【2】 :Carrier mode2 2-phase randomized PW M modulation

- Mode 0: 3-phase PWM Modulation Three Output transistors on at the same time (Full Duty).
- Mode 1: 2-phase PWM Modulation Two output transistors on at the same time (2/3 Duty).
- Mode 2: Random PWM Modulation This modulation method will use 3-phase PWM and 2-phase PWM modulation in a random mode.

Modes	Name	IGBT Duty	Heat Losses	Torque Performance	Waveform Distortion	Motor Noise
0	3-Phase PWM	100%	High	High	Low	Low
1	2-Phase PWM	66.6%	Low	Low	High	High
2	Randomized PWM	Between mode0 & mode1	Mid	Mid	Mid	Mid (Leverage)

11- 03	Carrier Frequency auto reduction due to temperature rise
Range	【0】 :Disable 【1】 :Enable

- When inverter (heatsink) temperature rises above 80°C the Carrier Frequency is reduced by 4K.
- When the temperature falls below less than 70°C, Carrier Frequency is reset to default.
- Temperature can be displayed by setting parameter 12-00=04000.

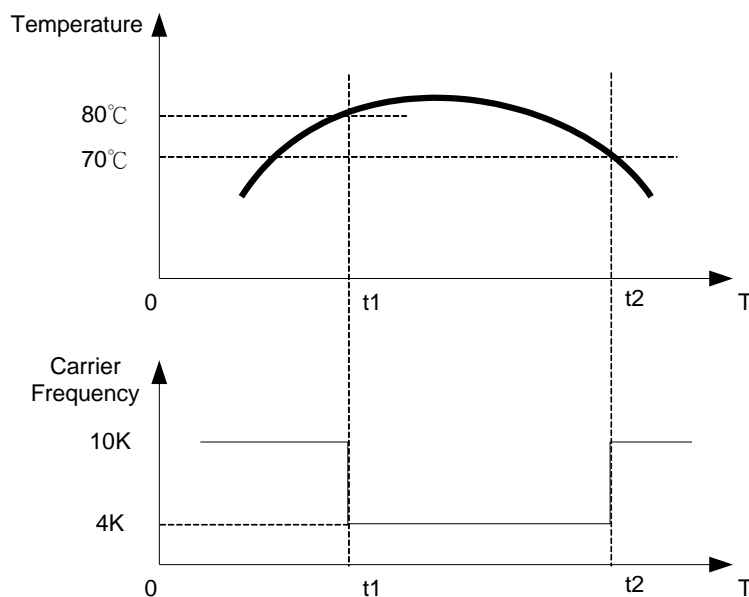

11-04	S-Curve Acc 1
11-05	S-Curve Acc 2
11-06	S-Curve Dec 3
11-07	S-Curve Dec 4
Range	【0.0 ~ 4.0】 s

- Use S Curve parameters where a smooth acceleration or deceleration action is required, this will prevent possible damage to driven machines by sudden acceleration/deceleration.

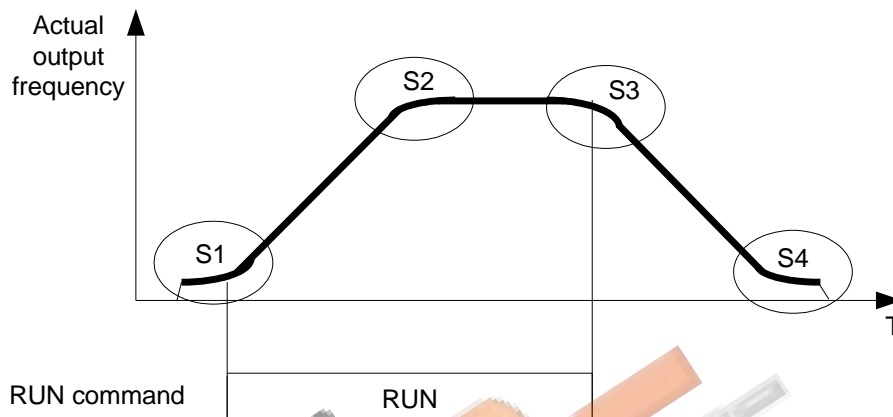

Note:

- Regardless of the stall prevention period, actual acceleration and deceleration time = preset acceleration / deceleration time + S curve time.
- Please set the required individual S curve times in the parameters (11-04~11-07).
- When S curve time (11-04~11-07) is set as 0, the S curve function is disabled.
- The calculation of S curve time is based on the Maximum output frequency of motor (01-02), Please refer to the parameters (00-14/00-15/00-16/00-17).

11-08	Skip frequency 1
11-09	Skip frequency 2
11-10	Skip frequency 3
Range	【0.00 ~ 650.00】 Hz
11-11	Skip frequency range. (\pm frequency band)
Range	【0.00 ~ 30.00】 Hz

Skip frequency parameters can be used to avoid mechanical resonance in certain applications.
 Example: 11-08=10.00(Hz); 11-09=20.00(Hz); 11-10=30.00(Hz); 11-11=2.00(Hz).

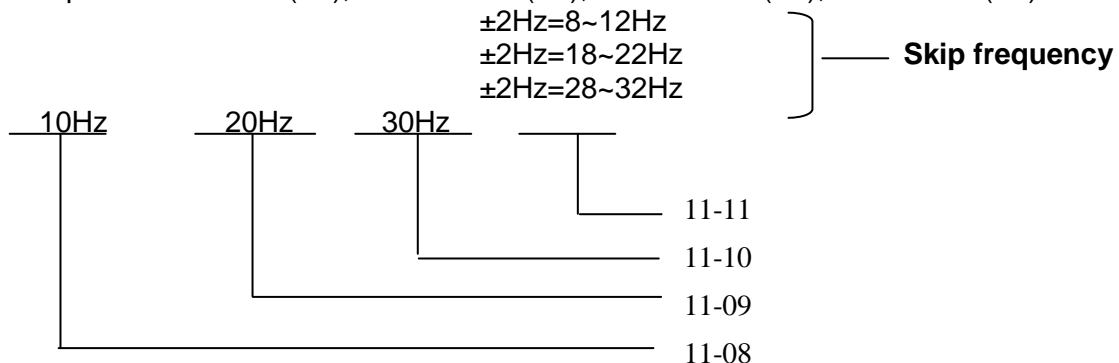

12 Monitor function group

12- 00	Display Mode
Range	<p>0 0 0 0 0 MSD LSD 00000~77777 Each digit can be set from 0 to 7 as listed below.</p> <p>【0】 :Disable display 【1】 :output Current 【2】 :output Voltage 【3】 :DC voltage 【4】 :Temperature 【5】 :PID feedback 【6】 :AVI 【7】 :ACI</p>

- MSD= Most significant digit. LSD= Least significant digit.
- Note: MSD of parameter 12-00 sets the power on display, other digits set user selected displays. (refer to P4-4)

12- 01	PID Feedback Display Mode
Range	<p>【0】 :Displayed in Integer (xxx) 【1】 :Displayed with One Decimal Place (xx.x) 【2】 :Displayed with Two Decimal Places (x.xx)</p>
12- 02	PID Feedback Display Unit Setting
Range	<p>【0】 :xxx-- 【1】 :xxxpb(pressure) 【2】 :xxxfl(flow)</p>

12- 03	Custom Units (Line Speed) Display Mode
Range	【0~65535】 rpm

- Set motor rated RPM in this parameter if required then the display will show this value when inverter output frequency reaches the motor name plate frequency. 50Hz or 60 Hz as appropriate.
- The line speed display is linearly proportional to the output frequency 0 to 50Hz or 0-60 Hz as appropriate. Motor synchronous speed = 120 x Rated frequency/Number of poles.

12- 04	Custom Units (Line Speed) Display Mode
Range	<p>【0】 :Drive Output Frequency is Displayed 【1】 :Line Speed is Displayed in Integer (xxxxx) 【2】 :Line Speed is Displayed with One Decimal Place (xxxx.x) 【3】 :Line Speed is Displayed with Two Decimal Places (xxx.xx) 【4】 :Line Speed is Displayed with Three Decimal Places (xx.xxx)</p>

- **12- 04≠0**, line speed is displayed while the inverter is running or stopped.

12- 05	Input and output terminal status display
Range	Read only(Panel read only)

- When any of S1 ~ S5 is turned on, corresponding segments on the digital display digits will be on.
- When relay output RY1 is on, the corresponding digit will be on as shown below.
- When no Digital input and no relay output, they will show - - - - .

Information
provided by
EMAG
Tel: 01902 601403
www.emag-ltd.co.uk

Example 1: The following figure shows 12 - 05 display status, when S1, S3, S5 Inputs are ON and S2, S4 and RY1 are OFF.

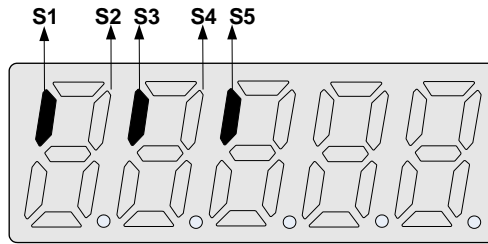

Example 2: The following figure shows 12 - 05 display status when S2, S3, S4 inputs are ON and S1, S5 are OFF but RY1 is ON.

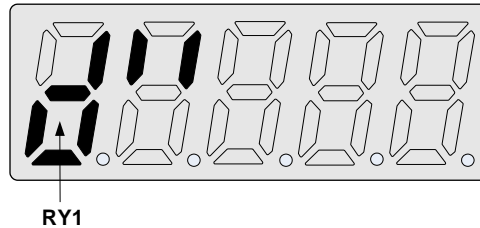

13 Inspection & Maintenance functions

13- 00	Drive Horsepower Code
Range	----

Inverter Model:	13- 00 show	Inverter Model:	13- 00 show	Inverter Model:	13- 00 show
L510-1P2-XXX	1P2	L510-2P2-XXX	2P2	L510-401-XXX	401
L510-1P5-XXX	1P5	L510-2P5-XXX	2P5	L510-402-XXX	402
L510-101-XXX	101	L510-201-XXX	201	L510-403-XXX	403
		L510-202-XXX	202		
		L510-203-XXX	203		

13- 01	Software Version
Range	----

13- 02	Fault Log Display (Latest 3 faults)
Range	----

- Last three faults are stored in a stack and whenever there is a new fault the previous faults are pushed down the stack. So the fault stored in 2.xxx will be transferred to 3.xxx, and the one in 1.xxx to 2.xxx. The recent fault will be stored in the empty register 1.xxx.
- Use Up▲ and Down▼ keys to scroll between the fault registers.
- Pressing reset key when parameter 13-02 is displayed then all three fault registers will be cleared and the display for each register will change to 1. ---, 2. ---, 3. ---.
- E.g. fault log content is '1.OC-C'; this indicates the latest fault is OC-C, etc.

13- 03	Accumulated Inverter Operation Time 1
Range	【0~23】 Hours
13- 04	Accumulated Inverter Operation Time 2

Range	【0~65535】 Days
13- 05	Accumulated Inverter Operation Time Mode
Range	【0】 :Power on time 【1】 :Operation time

- When the operation time recorded in accumulator 1 (Parameter 13-03) reaches 24 hours
- The recorded value in accumulator 2 parameter 13-04 changes to 1 day and the value in accumulator 1 is reset to 0000.

13- 06	Parameter lock
Range	【0】 :Enable all Functions 【1】 : Preset speeds 05- 01~05- 08 cannot be changed 【2】 :All Functions cannot be changed Except for preset speeds set in 05- 01~05- 08 【3】 :Disable All Function Except 13-06

- When the 13-07=00000 (not set a password), you can adjust the parameters 05-01~05-08 from 13-06.

13- 07	Parameter Lock Key Code
Range	【00000~65535】

- When a parameter lock key number is entered in parameter 13-07. For any parameter modification the key number has to be entered.
See following Parameter lock key setting example:-

- Setting Parameter lock key number example:-
Step1:

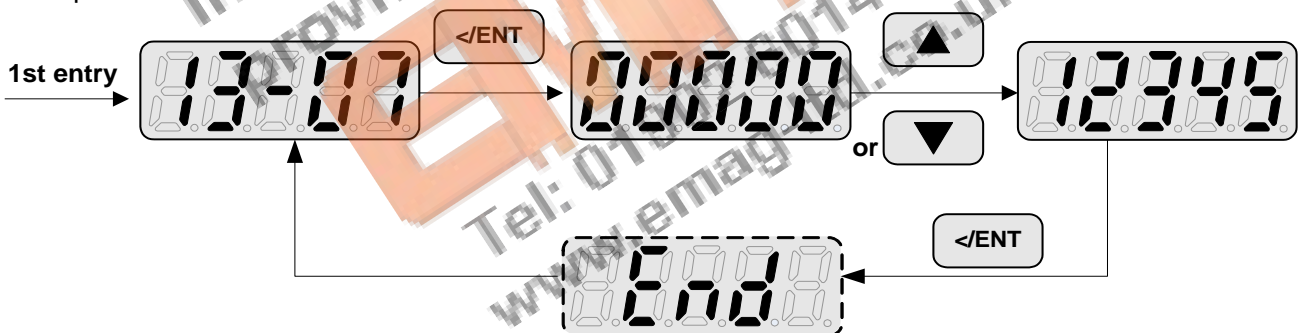

Step2:

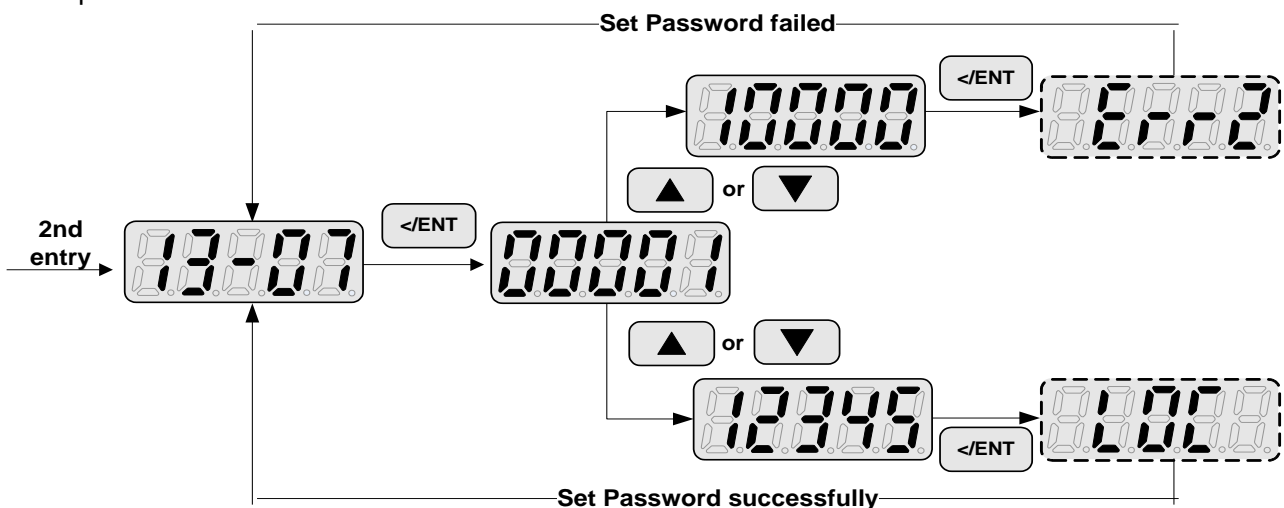

Key code (password) unlock

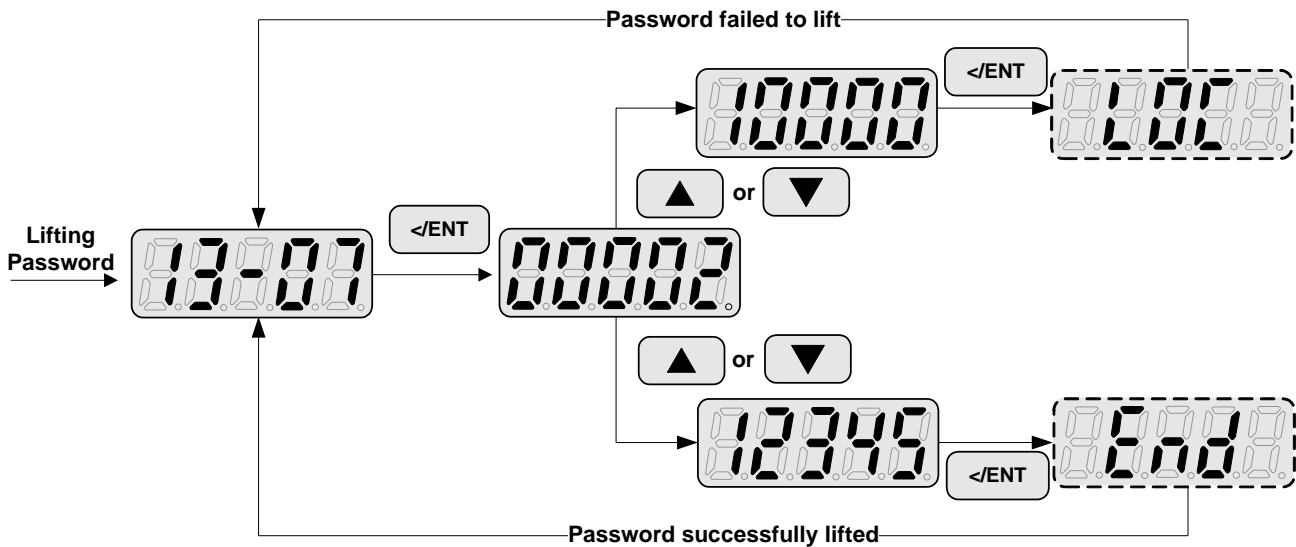

13- 08	Reset Drive to Factory Settings
Range	【1150】 :Reset to the 50Hz factory setting 【1160】 :Reset to the 60Hz factory setting

- When a Parameter lock key number has been entered in parameter 13 – 07. This key number must be entered first before parameter 13-08 can be used.

Information provided by
EMAG
 Tel: 01902 601403
 www.emag-ltd.co.uk

Chapter 5 Troubleshooting and maintenance

5.1 Error display and corrective action

5.1.1 Manual Reset and Auto-Reset

Faults which can not be recovered manually			
Display	content	Cause	Corrective action
-OV-	Voltage too high when stopped	Detection circuit malfunction	Consult with the supplier
-OU-			
-LV-	Voltage too low when stopped	1. Power voltage too low 2. Pre-charge resistor or fuse burnt out. 3. Detection circuit malfunction	1. Check if the power voltage is correct 2. failed resistor or fuse 3. Consult with the supplier
-LU-			
-OH-	The inverter is overheated when stopped	1. Detection circuit malfunction 2. Ambient temperature too high or bad ventilation	Improve the ventilation conditions, if no result then replace the inverter
-OH-			
OH-C	The inverter is overheated during running	1. IGBT temperature is too high or bad ventilation 2. temperature sensor error or circuit malfunctions	1. Reduce carrier frequency 2. Improve the ventilation conditions, if no result then replace the inverter
OH-C			
CtEr	Current Sensor detection error	Current sensor error or circuit malfunction	Consult with the supplier
CtEr			
EPr	EEPROM problem	Faulty EEPROM	Consult with the supplier
EPr			
COt	Communication error	Communications disruption	Check the wiring
COt			
Faults which can be recovered manually and automatically			
Display	content	Cause	Corrective action
OC-A	Over-current at acceleration	1. Acceleration time too short 2. The capacity of the motor exceeds the capacity of the inverter 3. Short circuit between the motor coil and the case 4. Short circuit between motor wiring and ground 5. IGBT module damaged	1. Set a longer acceleration time 2. Replace inverter with one that has the same rating as that of the motor 3. Check the motor 4. Check the wiring 5. Consult with the supplier
OC-A			
OC-C	Over-current at fixed speed	1. Transient load change 2. Transient power change	1. Increase the capacity of the inverter 2. Install inductor on the power supply input side
OC-C			
OC-d	Over-current at deceleration	The preset deceleration time is too short.	Set a longer deceleration time
OC-d			

OC-S	Over current at start	1.Short circuit between the motor coil and the case 2.Short circuit between motor coil and ground 3.IGBT module damaged	1.Inspect the motor 2.Inspect the wiring 3.Consult with the supplier
OC-S			
OV-C	Excessive Voltage during operation/ deceleration	1.Deceleration time setting too short or excessive load inertia 2.Power voltage varies widely (fluctuates)	1.Set a longer deceleration time 2.Consider use of a brake resistor and/or brake module (in case of 400V models) 3.Consider use of a reactor at the power input side
OU-C			
PF	Input phase Loss	Abnormal fluctuations in the main circuit voltage	1.Check the main circuit power supply wiring. 2.Check the power supply voltage
PF			

Faults which can be recovered manually but not automatically

Display	content	Cause	Corrective action
OC	Over-current during stop	Detection circuit malfunction	Consult with the supplier
OC			
OL1	Motor overload	loading too large	Consider increasing the Motor capacity
OL1			
OL2	Inverter overload	Excessive Load	Consider increasing the inverter capacity
OL2			
LV-C	Voltage too low during operation	1.Power voltage too low 2.Power voltage varies widely (fluctuates)	1.Improve power quality 2.Consider adding a reactor at the power input side
LU-C			

5.1.2 Keypad Operation Error Instruction

Display	content	Cause	Corrective action
LOC	1.Parameter already locked 2.Motor direction locked 3.Parameter password (13-07) enabled	1.Attempt to modify frequency parameter while 13-06>0. 2.Attempt to reverse direction when 11-00=1. 3.Parameter (13-07) enabled, set the correct password will show LOC.	1.Adjust 13-06 2.Adjust 11-00
LOC			
Err1	Keypad operation error	1.Press ▲ or ▼ while 00-05/00-06>0 or running at preset speed. 2.Attempt to modify the Parameter.Can not be modified during operation (refer to the parameter list)	1.The ▲ or ▼ is available for modifying the parameter only when 00-05/00-06=0 2.Modify the parameter in STOP mode.
Err 1			

Display	content	Cause	Corrective action
Err2	Parameter setting error	1.00-13 is within the range of (11-08 ±11-11) or (11-09 ±11-11) or (11-10 ±11-11) 2.00- 12 ≤ 00-13 3.set 00-05 and 00-06 to be same value 4.when 01-00 ≠ 7, modify parameter 01-01~01-09	1.Modify 11-08~11-10 or 11-11 Set 00-12>00-13
Err2			
Err5	Modification of parameter is not available in communication	1.Control command sent during communication. 2.Attempt to modify the function 09-02~ 09-05 during communication	1.Issue enable command before communication 2.Set parameters 09-02~ 09-05 function before communication
Err5			
Err6	Communication failed	1.Wiring error 2.Communication parameter setting error. 3.Incorrect communication protocol	1.Check hardware and wiring 2.Check Functions(09-00~ 09- 05).
Err6			
Err7	Parameter conflict	1.Attempt to modify the function 13-00/13-08. 2.Voltage and current detection circuit is abnormal.	If reset is not possible, please consult with the supplier.
Err7			

5.1.3 Special conditions

Display	Fault	Description
StP0	Zero speed at stop	Occurs when preset frequency <0.1Hz
StP0		
StP1	Fail to start directly On power up.	1. If the inverter is set for external terminal control mode (00-02/00-03=1) and direct start is disabled (07-04=1) 2. The inverter cannot be started and will flash STP1. 3. The run input is active at power-up, refer to descriptions of (07-04).
StP1		
StP2	Keypad Stop Operated when inverter in external Control mode.	1. If the Stop key is pressed while the inverter is set to external control mode (00-02/00-03=1) then 'STP2' flashes after stop. 2. Release and re-activate the run contact to restart the inverter.
E.S.	External Rapid stop	When external rapid stop input is activated the inverter will decelerate to stop and the display will flash with E.S. message.
E.S.		
b.b.	External base block	When external base block input is activated the inverter stops immediately and then the display will flash with b.b. message.
b.b.		
PdEr	PID feedback loss	PID feedback loss is detected.
PdEr		

5.2 General troubleshooting

Status	Checking point	Remedy
Motor runs in wrong direction	Is the wiring for the output terminals correct?	Wiring must match U, V, and W terminals of the motor.
	Is the wiring for forward and reverse signals correct?	Check for correct wiring.
The motor speed can not be regulated.	Is the wiring for the analog frequency inputs correct?	Check for correct wiring.
	Is the setting of operation mode correct?	Check the Frequency Source set in parameters 00-05/00-06.
	Is the load too excessive?	Reduce the load.
Motor running speed too high or too low	Check the motor specifications (poles, voltage...) correct?	Confirm the motor specifications.
	Is the gear ratio correct?	Confirm the gear ratio.
	Is the setting of the highest output frequency correct?	Confirm the highest output frequency
Motor speed varies unusually	Is the load too excessive?	Reduce the load.
	Does the load vary excessively?	1.Minimize the variation of the load. 2.Consider increasing the capacities of the inverter and the motor.
	Is the input power unstable or is there a phase loss ?	Consider adding an AC reactor at the power input side if using single-phase power. 2. Check wiring if using three-phase power
Motor can not run	Is the power connected to the correct L1, L2, and L3 terminals? is the charging indicator lit ?	1 Is the power applied? 2.Turn the power OFF and then ON again. 3.Make sure the power voltage is correct. 4.Make sure screws are secured firmly.
	Is there voltage across the output terminals T1, T2, and T3?	Turn the power OFF and then ON again.
	Is overload causing the motor to stall?	Reduce the load so the motor will run.
	Are there any abnormalities in the inverter?	See error descriptions to check wiring and correct if necessary.
	Is there a forward or reverse run command ?	
	Has the analog frequency signal been input?	1.Is analog frequency input signal wiring correct? 2.Is voltage of frequency input correct?
	Is the operation mode setting correct?	Operate through the digital keypad

5.3 Troubleshooting of the Inverter

Refer to the error display and corrective action section 5.1.

5.4 Routine and periodic inspection

To ensure stable and safe operations, check and maintain the inverter at regular intervals.

Use the checklist below to carry out inspection.

Disconnect power after approximately 5 minutes to make sure no voltage is present on the output terminals before any inspection or maintenance.

Items	Details	Checking period		Methods	Criteria	Remedies
		Daily	1Year			
Environment & Ground connection						
Ambient conditions at the installation	Confirm the temperature and humidity at the machine	◎		Measure with thermometer and hygrometer	Temperature: -10 ~40° C (14~120° F) Humidity: Below 95%RH	Improve the ambient or relocate the drive to a better area.
Installation Grounding	Is the grounding resistance correct?		◎	Measure the resistance with a multi-tester	200Vclass: below 100Ω	Improve the grounding if needed.
Terminals & Wiring						
Connection terminals	Any loose parts or terminals?		◎	Visual check Check with a screwdriver	Correct installation requirement	Secure terminals and remove rust
	Any damage to the base ?		◎			
	Any corroded Terminals?		◎			
Wiring	Any broken wires?		◎	Visual check	Correct wiring requirement	Rectify as necessary
	Any damage to the wire insulation?		◎			
voltage						
Input power voltage	Is the voltage of the main circuit correct?	◎		Measure the voltage with a multi-tester	Voltage must conform with the spec.	Improve input voltage if necessary.
Circuit boards and components						
Printed circuit board	Any contamination or damage to printed circuit board?		◎	Visual check	Correct component condition	Clean or replace the circuit board
Power component	Any dust or debris		◎			
		Check resistance between terminals		◎	Measure with a multi-tester	No short circuit or broken circuit in three phase output
Cooling System						
Cooling fan	Unusual vibration and noise?		◎	Visual and sound check	Correct cooling	Consult with the supplier
	Excessive dust or debris	◎		Visual check		Clean the fan
Heat sink	Excessive dust or debris	◎				Clean up debris or dust
Ventilation Path	Is the ventilation path blocked?	◎				Clear the path

5.5 Maintenance

To ensure long-term reliability, follow the instructions below to perform regular inspection. Turn the power off and wait for a minimum of 5 minutes before inspection to avoid potential shock hazard from the charge stored in high-capacity capacitors.

1. Maintenance Check List.

➤ Ensure that temperature and humidity around the inverters is as required in the instruction manual, installed away from any sources of heat and the correct ventilation is provided..
➤ For replacement of a failed or damaged inverter consult with the local supplier.
➤ Ensure that the installation area is free from dust and any other contamination.
➤ Check and ensure that the ground connections are secure and correct.
➤ Terminal screws must be tight, especially on the power input and output of the inverter.
➤ Do not perform any insulation test on the control circuit.

2. Insulation test Method . Single Phase

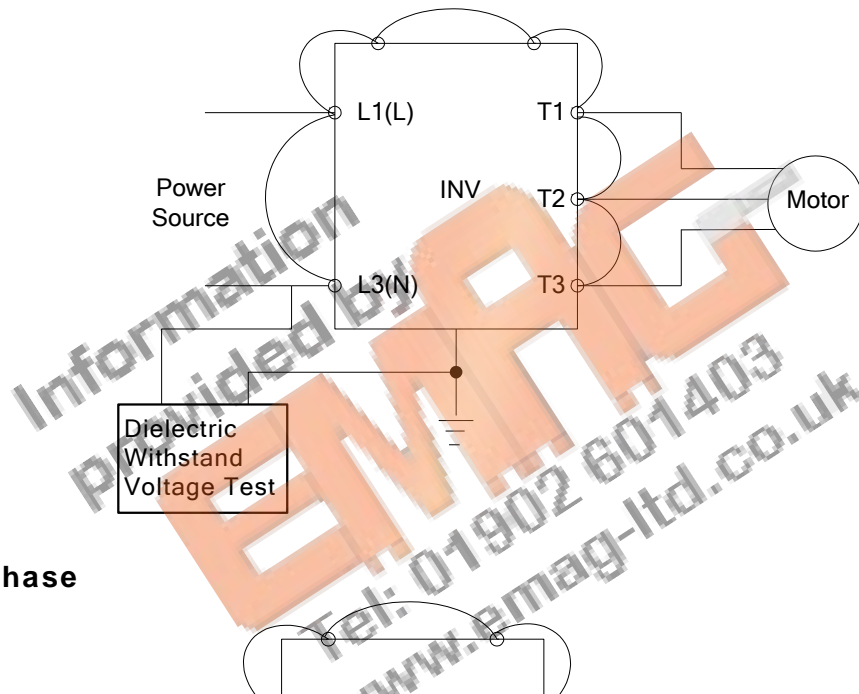

Three Phase

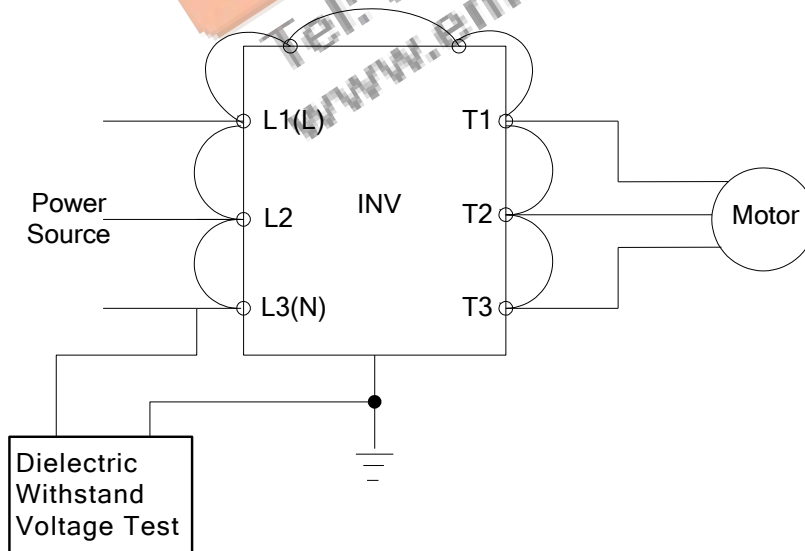

Chapter 6 Peripherals Components

6.1 Reactor Specifications

Model: L510-□□□-XXX-X □	Specification	
	Current (A)	Inductance (mH)
2P2	5.0	7.0
2P5	8.5	4.2
201	12	2.1
202	19.0	1.1
203	25.0	0.71
401	4.5	15.22
402	6	9.21
403	7.5	6.73

6.2 Electromagnetic Contactor and No fuse circuit breaker

Model: L510-□□□-XXX-X □	Molded-case circuit breaker made by TECO	Magnetic contactor (MC) made by TECO
1P2/1P5/2P2/2P5	TO-50E 15A	CN-11
101/201/202	TO-50E 20A	
203	TO-50E 30A	
401/402/403	TO-50E 15A	

6.3 Fuse Specification

Model: L510-□□□-XXX-X □	Rating
1P2/1P5	15A, 300VAC
101	20A, 300VAC
2P2	10A, 300VAC
2P5/201	15A, 300VAC
202/203	30A, 300VAC
401	5A, 600VAC
402	10A, 600VAC
403	15A, 600VAC

6.4 Fuse Specification(UL Model Recommended)

Model	Manufacture	Type	Rating
L510-1P2-H1X	Bussmann	16CT	16A, 690VAC
L510-1P5-H1X	Bussmann	20CT	20A, 690VAC
L510-101-H1X	Bussmann	25ET	25A, 690VAC
L510-2P2-H1/H1F	Bussmann	10CT	10A, 690VAC
L510-2P5-H1/H1F	Bussmann	10CT/16CT	10A/16A, 690VAC
L510-201-H1/H1F	Bussmann	16CT/20CT	16A/20A, 690VAC
L510-202-H1/H1F	Bussmann	30FE	30A, 690VAC
L510-203-H1/H1F	Bussmann	50FE	50A, 690VAC
L510-2P2-H3	Bussmann	10CT	10A, 690VAC
L510-2P5-H3	Bussmann	10CT	10A, 690VAC
L510-201-H3	Bussmann	10CT	10A, 690VAC

Model	Manufacture	Type	Rating
L510-202-H3	Bussmann	16CT	16A, 690VAC
L510-203-H3	Bussmann	20CT	20A, 690VAC
L510-401-H3	Bussmann	10CT	10A, 690VAC
L510-402-H3	Bussmann	16CT	16A, 690VAC
L510-403-H3	Bussmann	16CT	16A, 690VAC

6.5 Braking Resistor. 400V range

Model : L510-□□□-XXX	(HP)	(KW)	recomanded Braking resistor			ED(%)	braking torque (%)	min Braking resistor		
			(W)	(Ω)	Parallel Number			(W)	(Ω)	Parallel Number
401	1	0.75	60	750	-	8	123	400	120	-
402	2	1.5	150	400	-	10	117	500	120	-
403	3	2.2	200	250	-	8	123	500	100	-

※Note: Braking resistor : $W = (V_{pnb} * V_{pnb}) * ED\% / R_{min}$

1. W: The power consumption of braking action
2. Vpnb: The voltage of braking action (220V=380VDC, 440V=760VDC)
3. ED%: The effective period of braking action
4. Rmin: braking resistor minimum value (ohms)

Information provided by
EMAG
 Tel: 01902 601403
www.emag-ltd.co.uk

Appendix I L510 parameters setting list

Customer				Inverter Model			
Using Site				Contact Phone			
Address							
Parameter Code	Setting Content	Parameter Code	Setting Content	Parameter Code	Setting Content	Parameter Code	Setting Content
00-00		03-04		05-17		07-01	
00-01		03-05		05-18		07-02	
00-02		03-06		05-19		07-03	
00-03		03-07		05-20		07-04	
00-04		03-08		05-21		07-05	
00-05		03-09		05-22		07-06	
00-06		03-10		05-23		07-07	
00-07		03-11		05-24		07-08	
00-08		03-12		05-25		08-00	
00-09		03-13		05-26		08-01	
00-10		03-14		05-27		08-02	
00-11		03-15		05-28		08-03	
00-12		03-16		05-29		08-04	
00-13		03-17		05-30		08-05	
00-14		03-18		05-31		08-06	
00-15		03-19		05-32		08-07	
00-16		04-00		06-00		08-08	
00-17		04-01		06-01		08-09	
00-18		04-02		06-02		09-00	
00-19		04-03		06-03		09-01	
00-20		04-04		06-04		09-02	
01-00		04-05		06-05		09-03	
01-01		04-06		06-06		09-04	
01-02		04-07		06-07		09-05	
01-03		04-08		06-16		09-06	
01-04		04-09		06-17		09-07	
01-05		04-10		06-18		09-08	
01-06		04-11		06-19		09-09	
01-07		04-12		06-20		10-00	
01-08		04-13		06-21		10-01	
01-09		04-14		06-22		10-02	
01-10		04-15		06-23		10-03	
01-11		05-00		06-32		10-04	
02-00		05-01		06-33		10-05	
02-01		05-02		06-34		10-06	
02-02		05-03		06-35		10-07	
02-03		05-04		06-36		10-08	
03-00		05-05		06-37		10-09	
03-01		05-06		06-38		10-10	
03-02		05-07		06-39		10-11	
03-03		05-08		07-00		10-12	

Parameter Code	Setting Content	Parameter Code	Setting Content	Parameter Code	Setting Content	Parameter Code	Setting Content
10-13		11-02		12-03			
10-14		11-03		12-04			
10-15		11-04		12-05			
10-16		11-05		13-00			
10-17		11-06		13-01			
10-18		11-07		13-02			
10-19		11-08		13-03			
10-20		11-09		13-04			
10-21		11-11		13-05			
10-22		12-00		13-06			
11-00		12-01		13-07			
11-01		12-02		13-08			

Information
provided by
EMAG
Tel: 01902 601403
www.emag-ltd.co.uk

Appendix-2 Instructions for UL

◆ Safety Precautions

DANGER

Electrical Shock Hazard

Do not connect or disconnect wiring while the power is on.

Failure to comply will result in death or serious injury.

WARNING

Electrical Shock Hazard

Do not operate equipment with covers removed.

Failure to comply could result in death or serious injury.

The diagrams in this section may show drives without covers or safety shields to show details. Be sure to reinstall covers or shields before operating the drives and run the drives according to the instructions described in this manual.

Always ground the motor-side grounding terminal.

Improper equipment grounding could result in death or serious injury by contacting the motor case.

Do not touch any terminals before the capacitors have fully discharged.

Failure to comply could result in death or serious injury.

Before wiring terminals, disconnect all power to the equipment. The internal capacitor remains charged even after the power supply is turned off. After shutting off the power, wait for at least the amount of time specified on the drive before touching any components.

Do not allow unqualified personnel to perform work on the drive.

Failure to comply could result in death or serious injury.

Installation, maintenance, inspection, and servicing must be performed only by authorized personnel familiar with installation, adjustment, and maintenance of AC drives.

Do not perform work on the drive while wearing loose clothing, jewelry, or lack of eye protection.

Failure to comply could result in death or serious injury.

Remove all metal objects such as watches and rings, secure loose clothing, and wear eye protection before beginning work on the drive.

Do not remove covers or touch circuit boards while the power is on.

Failure to comply could result in death or serious injury.

Fire Hazard

Tighten all terminal screws to the specified tightening torque.

Loose electrical connections could result in death or serious injury by fire due to overheating of electrical connections.

Do not use an improper voltage source.

Failure to comply could result in death or serious injury by fire.

Verify that the rated voltage of the drive matches the voltage of the incoming power supply before applying power.

Do not use improper combustible materials.

Failure to comply could result in death or serious injury by fire.

Attach the drive to metal or other noncombustible material.

NOTICE

Observe proper electrostatic discharge procedures (ESD) when handling the drive and circuit boards.

Failure to comply may result in ESD damage to the drive circuitry.

Never connect or disconnect the motor from the drive while the drive is outputting voltage.

Improper equipment sequencing could result in damage to the drive.

Do not use unshielded cable for control wiring.

Failure to comply may cause electrical interference resulting in poor system performance. Use shielded twisted-pair wires and ground the shield to the ground terminal of the drive.

NOTICE

Do not modify the drive circuitry.

Failure to comply could result in damage to the drive and will void warranty.

Teco is not responsible for any modification of the product made by the user. This product must not be modified.

Check all the wiring to ensure that all connections are correct after installing the drive and connecting any other devices.

Failure to comply could result in damage to the drive.

◆ UL Standards

The UL/cUL mark applies to products in the United States and Canada and it means that UL has performed product testing and evaluation and determined that their stringent standards for product safety have been met. For a product to receive UL certification, all components inside that product must also receive UL certification.



◆ UL Standards Compliance

This drive is tested in accordance with UL standard UL508C and complies with UL requirements. To ensure continued compliance when using this drive in combination with other equipment, meet the following conditions:

■ Installation Area

Do not install the drive to an area greater than pollution severity 2 (UL standard).

■ Main Circuit Terminal Wiring

UL approval requires crimp terminals when wiring the drive's main circuit terminals. Use crimping tools as specified by the crimp terminal manufacturer. Teco recommends crimp terminals made by NICHIFU for the insulation cap.

The table below matches drives models with crimp terminals and insulation caps. Orders can be placed with a Teco representative or directly with the Teco sales department.

Closed-Loop Crimp Terminal Size

Drive Model	Wire Gauge mm ² (AWG)						Terminal	Crimp Terminal	Tool	Insulation Cap
	R/L1	S/L2	T/L3	U/T1	V/T2	W/T3				
L510							Screws	Model No.	Machine No.	Model No.
1P2	1.3(16)						M3.5	R2-3.5	Nichifu NH 1 / 9	TIC 2
1P5	2.1 (14)									TIC 2
101	3.3(12)						M4	R3.5-4	Nichifu NH 1 / 9	TIC 3.5
2P2	1.3(16)						M3.5	R2-3.5	Nichifu NH 1 / 9	TIC 2
2P5	1.3 (16)								Nichifu NH 1 / 9	TIC 2
201	2.1 (14)								Nichifu NH 1 / 9	TIC 2
202	3.3(12)								R3.5-4	Nichifu NH 1 / 9
203	5.3(10)						M4	R5.5-4	Nichifu NH 1 / 9	TIC 3.5
401	2.1 (14)							R3.5-4	Nichifu NH 1 / 9	TIC 2
402	2.1 (14)								Nichifu NH 1 / 9	TIC 2
403	2.1 (14)								Nichifu NH 1 / 9	Nichifu NH 1 / 9
							Nichifu NH 1 / 9			

◆Type 1

During installation, all conduit hole plugs shall be removed, and all conduit holes shall be used.

Recommended Input Fuse Selection

Drive Model L510	Fuse Type	
	Manufacturer: Bussmann	
	Model	Fuse Ampere Rating (A)
100 V Class Single-Phase Drives		
1P2	Bussmann 16CT	690V 16A
1P5	Bussmann 20CT	690V 20A
101	Bussmann 25ET	690V 25A

Drive Model L510	Fuse Type	
	Manufacturer: Bussmann	
	Model	Fuse Ampere Rating (A)
200 V Class Single-Phase Drives		
2P2	Bussmann 10CT	690V 10A
2P5	Bussmann 10CT/16CT	690V 10A / 690V 16A
201	Bussmann 16CT/20CT	690V 16A / 690V 20A
202	Bussmann 30FE	690V 30A
203	Bussmann 50FE	690V 50A

Drive Model L510	Fuse Type	
	Manufacturer: Bussmann	
	Model	Fuse Ampere Rating (A)
200 V Class Three-Phase Drives		
2P2	Bussmann 10CT	690V 10A
2P5	Bussmann 10CT	690V 10A
201	Bussmann 10CT	690V 10A
202	Bussmann 16CT	690V 16A
203	Bussmann 20CT	690V 20A

Drive Model L510	Fuse Type	
	Manufacturer: Bussmann	
	Model	Fuse Ampere Rating (A)
400 V Class Three-Phase Drives		
401	Bussmann 10CT	690V 10A
402	Bussmann 16CT	690V 16A
403	Bussmann 20CT	690V 20A

◆ Motor Overtemperature Protection

Motor overtemperature protection shall be provided in the end use application.

■

■ Field Wiring Terminals

All input and output field wiring terminals not located within the motor circuit shall be marked to indicate the proper connections that are to be made to each terminal and indicate that copper conductors, rated 75°C are to be used.

■ Drive Short-Circuit Rating

This drive has undergone the UL short-circuit test, which certifies that during a short circuit in the power supply the current flow will not rise above value. Please see electrical ratings for maximum voltage and table below for current.

- The MCCB and breaker protection and fuse ratings (refer to the preceding table) shall be equal to or greater than the short-circuit tolerance of the power supply being used.
- Suitable for use on a circuit capable of delivering not more than (A) RMS symmetrical amperes for (Hp) Hp in 240 / 480 V class drives motor ■ overload protection.

Horse Power (Hp)	Current (A)	Voltage (V)
1 - 50	5,000	240 / 480
51 - 200	10,000	240 / 480
201 - 400	18,000	240 / 480
401 - 600	30,000	240 / 480

◆ Drive Motor Overload Protection

Set parameter 02-01 (motor rated current) to the appropriate value to enable motor overload protection. The internal motor overload protection is UL listed and in accordance with the NEC and CEC.

■ 02-01 Motor Rated Current

Setting Range: Model Dependent

Factory Default: Model Dependent

The motor rated current parameter (02-01) protects the motor and allows for proper vector control when using open loop vector or flux vector control methods (00-00 = 2 or 3). The motor protection parameter 08-05 is set as factory default. Set 02-01 to the full load amps (FLA) stamped on the nameplate of the motor.

■ 08-05 Motor Overload Protection Selection

The drive has an electronic overload protection function (OL1) based on time, output current, and output frequency, which protects the motor from overheating. The electronic thermal overload function is UL-recognized, so it does not require an external thermal overload relay for single motor operation.

This parameter selects the motor overload curve used according to the type of motor applied.

Overload Protection Settings

Setting	Description
---0B	Disabled
---1B	Enabled

Sets the motor overload protection function in 08-05 according to the applicable motor.

Setting 08-05 = ---0B. Disables the motor overload protection function when two or more motors are connected to a single inverter. Use an alternative method to provide separate overload protection for each motor such as connecting a thermal overload relay to the power line of each motor.

■

Motor Overload Protection Time

■ 08-06 Motor Overload Operation Selection

Setting	Description
0	Free Run to Stop (default setting)
1	Alarm Only

Appendix 3: L510 MODBUS Communication protocol

1. Communication Data Frame

L510series inverter can be controlled by a PC or other controller with the Communication protocol, Modbus ASCII Mode & Mode RTU, RS485 or RS232. Frame length maximum 80 bytes.

1.1 Hardware installation

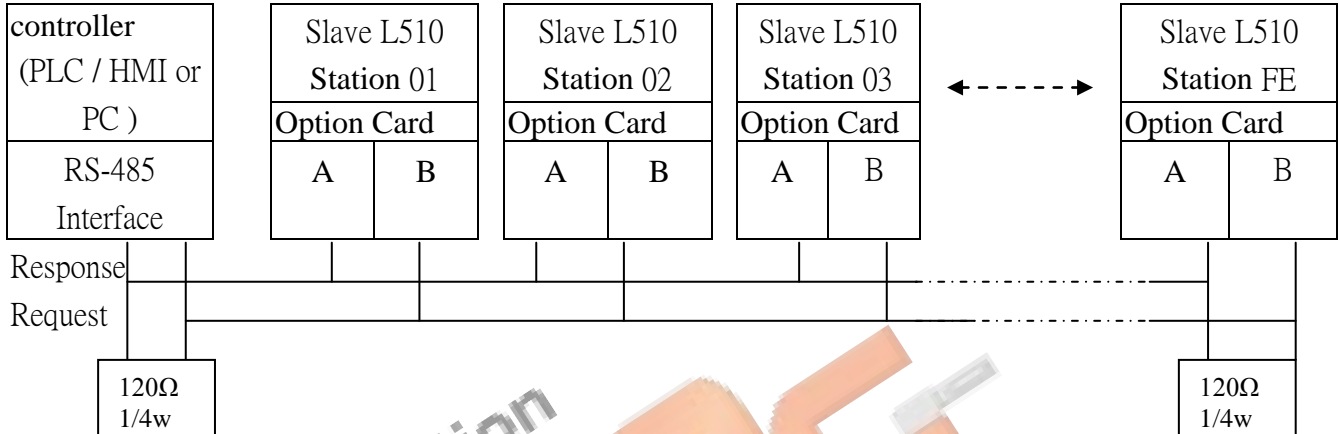

** The network is terminated at each end with an external terminating resistor (120Ω, 1/4w)**

1.2 Data format ASCII MODE

STX(3AH)	Start bit = 3AH
Address Hi	Communication Address(Station):
Address Lo	2-digit ASCII Code
Function Hi	Function Code (command):
Function Lo	2-digit ASCII Code
Command Start Address	Command Start byte:
Command Start Address	4-digit ASCII Code
Command Start Address	
Command Start Address	
Data length	The length of the command:
Data length	4-digit ASCII Code
Data length	
Data length	
LRC Check Hi	LRC Check Code:
LRC Check Lo	2-digit ASCII Code
END Hi	End Byte :
END Lo	END Hi = CR(0DH) , END Lo= LF(0AH)

MASTER(PLC etc.) send request to SLAVE, whereas response to MASTER.

The signal receiving is illustrated here.

The data length is varied with the command(Function).

SLAVE Address
Function Code
DATA
CRC CHECK
Signal Interval

** The interval should be maintained at 10ms between command signal and request.

1.3 SLAVE(Address)

00H : Broadcast to all the drivers

01H : to the No.01 Drivers

0FH : to the No.15 Drivers

10H : to the No.16 Drivers

and so on...., Max to 32(20H)

1.4 Function Code

03H : Read the register contents

06H : write a WORD to register

08H : Loop test

10H : write several data to register(complex number register write)

2.CMS (Checksum and time-out definition)

2.1 LRC CHECK

ex: ADDRESS 01H
 FUNCTION 03H
 COMMAND 01H
 00H
 DATA LENGTH 0AH

 0FH-----true complement
 Checksum = F1H
 CS(H) = 46H (ASCII)
 CS(L) = 31H (ASCII)

2.2 CRC CHECK: CRC Check Code is calculated from SLAVE Address to end of the data.

The calculation method is illustrated as follow:

- (1). Load a 16-bit register with FFFF hex (all's1). Call this the CRC register.
- (2). Exclusive OR the first 8-bit byte of the message with the low-order byte of the 16-bit CRC register, putting the result in the CRC register.
- (3). Shift the CRC register one bit to the right (toward the LSB), Zero-filling the MSB, Extract and examines the LSB.
- (4). (If the LSB was 0): Repeat Steps(3)(another shift). (If the LSB was 1): Exclusive OR the CRC register with the polynomial value A001 hex (1010 0000 0000 0001), putting the result in the CRC register.
- (5). Repeat Steps (3) and (4) until 8 shifts been performed. When this is done, a complete 8-bit byte will be processed .
- (6). Repeat Steps (2) through (5) for next 8-bit byte of the message, Continue doing this until all bytes have been processed. The final content of the CRC register is the CRC value. Placing the CRC into the message: When the 16-bit CRC (2 8-bit bytes) is transmitted in the message, the Low-order byte will be transmitted first, followed by the high-order byte, For example, if the CRC value is 1241 hex, the CRC-16 Upper put the 41h, the CRC-16 Lower put the 12h.

● **CRC calculation application program**

```
UWORD ch_sum ( UBYTE long , UBYTE *rxdbuf )
```

```
{
    BYTE i = 0;
    UWORD wkg = 0xFFFF;
    while ( long-- )
    {
        wkg ^= rxdbuf++;
        for ( i = 0 ; i < 8; i++ )
        {
            if ( wkg & 0x0001 )
            {
                wkg = ( wkg >> 1 ) ^ 0xa001;
            }
            else
            {
                wkg = wkg >> 1;
            }
        }
    }
    return( wkg );
}
```

3. Error code

ASCII Mode

STX	‘.’
Address	‘0’
	‘1’
Function	‘8’
	‘6’
Exception code	‘5’
	‘1’
LRC Check	‘2’
	‘8’
END	‘CR’
	‘LF’

RTU Mode

SLAVE Address	02H	
Function	83H	
Exception code	52H	
CRC-16	High	C0H
	Low	CDH

Under communication linking, the driver responses the Exception Code and send Function Code AND 80H to main system if there is error happened.

Error Code	Description
51	Function Code Error
52	Address Error
53	Data Amount Error
54	DATA Over Range
55	Writing Mode Error

4 Inverter Control

4.1 Command Data (Readable and Writable)

Register No.	Bit	Content
2500H	Reserved	
2501H		Operation Signal
	0	Operation Command 1 : Run 0 : Stop
	1	Reverse Command 1 : Reverse 0 : Forward
	2	Abnormal 1 : EFO
	3	Fault Reset 1 : Reset
	4	Jog Forward Command 1 : Jog Forward
	5	Jog Reverse Command 1 : Jog Reverse
	6	Multi-function CommandS1 1 : "ON" 0 : "OFF"
	7	Multi-function CommandS2 1 : "ON" 0 : "OFF"
	8	Multi-function CommandS3 1 : "ON" 0 : "OFF"
	9	Multi-function CommandS4 1 : "ON" 0 : "OFF"
	A	Multi-function CommandS5 1 : "ON" 0 : "OFF"
	B	Reserved
	C	Relay R1 1 : "ON" 0 : "OFF"
	D	Reserved
	E~F	Reserved
2502H	Frequency Command	
2503~251FH	Reserved	

Note: Write in zero for Not used BIT, do not write in data for the reserved register.

4.2 Monitor Data(Only for reading)

Register No.	Bit	Content
2520H		
	0	Operation state 1 : Run 0 : Stop
	1	Direction state 1 : Reverse 0 : Forward
	2	Inverter operation prepare state 1:ready 0 : unready
	3	Abnormal 1 : Abnormal
	4	DATA setting error 1 : Error
5-F	Reserved	

Information
provided by
EMAG
Tel: 01902 601403
www.emag-ltd.co.uk

Register No.	Content		
2521H	abnormity		
	00	The inverter is normal	20 Over current during decelerating)(OC-D)
	01	Inverter over heat)(OH)	21 (OC_S)
	02	Over current at stop)(OC)	22 Reserved
	03	Under voltage(LV)	23 Under voltage during running(LV-C)
	04	Over voltage)(OV)	24 Over voltage at constant speed(OV-C)
	05	Reserved	25 Inverter over heat during running(OH-C)
	06	External BB(bb)	26 stop at 0 Hz(STP0)
	07	(CTER)	27 Direct start disable)(STP1)
	08	(PDER)	28 Control panel emergency stop(STP2)
	09	(EPR)	29 Keypad operation error)(Err1)
	10	(ATER)	30 Parameter setting error(Err2)
	11	(OL3)	31 (Err4)
	12	Inverter over load(OL510)	32 Communication failure) (Err5)
	13	Motor over load(OL1)	33 Communication failure(Err6)
	14	(EFO)	34 (Err7)
	15	External bb E.S)	35 (Err8)
	16	(LOC)	36 Reserved
	17	Reserved	37 Reserved
	18	Over voltage at constant speed (OC-C)	38 (EPR1)
	19	Over current during accelerating)(OC-A)	39 (EPR2)
40	Inverter over speed(OVSP)		
2522H	Sequence input status		
	0	Terminal S1	1 :“ON” 0:“OFF”
	1	Terminal S2	1 :“ON” 0:“OFF”
	2	Terminal S3	1 :“ON” 0:“OFF”
	3	Terminal S4	1 :“ON” 0:“OFF”
	4	Terminal S5	1 :“ON” 0:“OFF”
	5	Terminal S6	1 :“ON” 0:“OFF”
	Contact output		
	6	Relay R1	1 :“ON” 0:“OFF”
	7	Relay R2	1 :“ON” 0:“OFF”
	9~F	Reserved	

Register No.	Content
2523H	frequency command(100/1Hz)
2524H	Output frequency (100/1Hz)
2525H	Output voltage command (10/1V)
2526H	DC voltage command (1/1V)
2527H	Output current (10/1A)
2528H	reserved
2529H	reserved
252AH	PID feedback (100% / fmax , 10/1%)
252BH	PID input (100% / fmax, 10/1%)
252CH	TM2 AVI input value (1000 / 10V) *1
252DH	TM2 ACI input value (1000 / 10V) *1
252EH	reserved
252FH	L510 identification: 0x0100

Information
provided by
EMAG
Tel: 01902 601403
www.emag-ltd.co.uk

4.3 Read the data in the holding register [03H]

Master unit reads the contents of the holding register with the continuous number for the specified quantity.

- Note: 1、 Limit number of read data, RTU: 37, ASCII:17.
 2、 Can only Continuous read the address of the same Group
 3、 Read data Quantity≥1.

(Example) Read the SLAVE station No:01 ,L510 drive's frequency command.

ASCII Mode

Instruction Message		Response Message (Normal)		Response(Fault)	
3AH	STX	3AH	STX	3AH	STX
30H	SLAVE Address	30H	SLAVE Address	30H	SLAVE Address
31H		31H		31H	
30H	Function Code	30H	Function Code	38H	Function Code
33H		33H		33H	
41H	Start Address	30H	DATA Number	35H	Error Code
30H		32H		32H	
32H		31H	First holding register	?	LRC CHECK
33H		37H		?	
30H	Quantity	37H	LRC CHECK	0DH	END
30H		30H		0AH	
30H		?			
31H		?			
?	LRC CHECK	0DH	END		
?		0AH			
0DH	END				
0AH					

RTU Mode

Instruction Message		Response Message (Normal)		Response(Fault)	
SLAVE Address	01H	SLAVE Address	01H	SLAVE Address	01H
Function Code	03H	Function Code	03H	Function Code	83H
Start Address	High	DATA Number	02H	Error Code	52H
	Low	High	07H	CRC-16	High
Quantity	High	Low	D0H		Low
	Low	High	BBH		
CRC-16	High	Low	E8H		
	Low				

4.4 LOOP BACK testing [08H]

The function code checks communication between MASTER and SLAVE, the Instruction message is returned as a response message without being changed, Any values can be used for test codes or data.

ASCII Mode

Instruction Message		Response Message (Normal)		Response(Fault)	
3AH	STX	3AH	STX	3AH	STX
30H	SLAVE Address	30H	SLAVE Address	30H	SLAVE Address
31H		31H		31H	
30H	Function Code	30H	Function Code	38H	Function Code
38H		38H		38H	
30H	Test Code	30H	Test Code	32H	Error Code
30H		30H		30H	
30H		30H		37H	LRC CHEC
30H		30H		35H	
41H	DATA	41H	DATA	0DH	END
35H		35H		0AH	
33H		33H			
37H		37H			
31H	LRC CHECK	31H	LRC CHECK		
42H		42H			
0DH	END	0DH	END		
0AH		0AH			

RTU Mode

Instruction Message			Response Message (Normal)			Response(Fault)		
SLAVE Address	01H		SLAVE Address	01H		SLAVE Address	01H	
Function Code	08H		Function Code	08H		Function Code	88H	
Test Code	High	00H	Test Code	High	00H	Error Code	20H	
	Low	00H		Low	00H	CRC-16	High	47H
DATA	High	A5H	DATA	High	A5H		Low	D8H
	Low	37H		Low	37H			
CRC-16	High	DAH	CRC-16	High	DAH			
	Low	8DH		Low	8DH			

4.5 Write holding register [06H]

Specified data are written into the several specified holding registers from the Specified respectively.

(Example)Set SLAVE station No:01, write L510 drive frequency reference 60.0HZ.

ASCII Mode

Instruction Message		Response Message (Normal)		Response(Fault)	
3AH	STX	3AH	STX	3AH	STX
30H	SLAVE	30H	SLAVE	30H	SLAVE
31H	Address	31H	Address	31H	Address
30H	Function	30H	Function Code	38H	Function Code
36H	Code	36H		36H	
41H	Start Address	41H	Start Address	35H	Error Code
30H		30H		32H	
30H		30H		?	
32H		32H		?	
31H	DATA	31H	DATA	0DH	END
37H		37H		0AH	
37H		37H			
30H		30H			
?		LRC CHECK		?	LRC CHECK
?	?				
0DH	END	0DH	END		
0AH		0AH			

RTU Mode

Instruction Message			Response Message (Normal)			Response(Fault)		
SLAVE Address		01H	SLAVE Address		01H	SLAVE Address		01H
Function Code		06H	Function Code		06H	Function Code		86H
Start Address	High	A0H	Start Address	High	A0H	Error Code		52H
	Low	02H		DATA	Low	02H	CRC-16	High
DATA	High	17H	DATA		High	17H		CRC-16
	Low	70H		CRC-16	Low	70H		
CRC-16	High	04H	CRC-16		High	04H		
	Low	1EH		CRC-16	Low	1EH		

4.6 Write in several holding registers [10H]

Specified data are written into the several specified holding registers from the Specified number respectively.

- Note:1、 Limit number of read data, RTU: 35, ASCII:15.
 2、 Can only Continuous read the address of the same Group.
 3、 Read data Quantity≥1.

(Example)Set SLAVE station No:01, L510 drive as forward run at frequency reference 60.0HZ.

ASCII Mode

Instruction Message		Response Message (Normal)		Response(Fault)	
3AH	STX	3AH	STX	3AH	STX
30H	SLAVE Address	30H	SLAVE Address	30H	SLAVE Address
31H		31H		31H	
31H	Function Code	31H	Function Code	39H	Function Code
30H		30H		30H	
41H	Start Address	41H	Start Address	35H	Error Code
30H		30H		32H	
30H		30H		?	LRC CHECK
31H		31H		?	
30H	Quantity	30H	Quantity	0DH	END
30H		30H		0AH	
30H		30H			
32H		32H			
30H	DATA Number *	?	LRC CHECK		
34H		?			
30H	First DATA	0DH	END		
30H		0AH			
30H					
31H					
31H	Next DATA				
37H					
37H					
30H					
?	LRC CHECK				
?					
0DH	END				
0AH					

RTU Mode

Instruction Message

SLAVE Address		01H
Function Code		10H
Start Address	High	A0H
	Low	01H
Quantity	High	00H
	Low	02H
DATA Number *		04H
First DATA	High	00H
	Low	01H
Next DATA	High	17H
	Low	70H
CRC-16	High	95H
	Low	B0H

Response Message (Normal)

SLAVE Address		01H
Function Code		10H
Start Address	High	A0H
	Low	01H
Quantity	High	00H
	Low	02H
CRC-16	High	32H
	Low	08H

Response(Fault)

SLAVE Address		01H
Function Code		90H
Error Code		52H
CRC-16	High	CDH
	Low	FDH

* DATA Numbers are the actual number timers 2

Information
provided by
EMAG
Tel: 01902 601403
www.emag-ltd.co.uk

5.Comparison list between parameter and register

Note:

Parameter register No.: GGnnH, “GG”means Group number , “nn” means Parameter number

for example: the address of Pr 08-03 is 0803H. the address of Pr 10-11 is 0A0BH

Register No.	Function	Register No.	Function	Register No.	Function
Group00		Group01		Group02	
0000H	00-00	0100H	01-00	0200H	02-00
0001H	00-01	0101H	01-01	0201H	02-01
0002H	00-02	0102H	01-02	0202H	02-02
0003H	00-03	0103H	01-03	0203H	02-03
0004H	00-04	0104H	01-04		
0005H	00-05	0105H	01-05		
0006H	00-06	0106H	01-06		
0007H	00-07	0107H	01-07		
0008H	00-08	0108H	01-08		
0009H	00-09	0109H	01-09		
000AH	00-10	010AH	01-10		
000BH	00-11	010BH	01-11		
000CH	00-12				
000DH	00-13				
000EH	00-14				
000FH	00-15				
0010H	00-16				
0011H	00-17				
0012H	00-18				
0013H	00-19				
0014H	00-20				

Register No.	Function	Register No.	Function	Register No.	Function
Group03		Group04		Group05	
0300H	03-00	0400H	04-00	0500H	05-00
0301H	03-01	0401H	04-01	0501H	05-01
0302H	03-02	0402H	04-02	0502H	05-02
0303H	03-03	0403H	04-03	0503H	05-03
0304H	03-04	0404H	04-04	0504H	05-04
0305H	03-05	0405H	04-05	0505H	05-05
0306H	03-06	0406H	04-06	0506H	05-06
0307H	03-07	0407H	04-07	0507H	05-07
0308H	03-08	0408H	04-08	0508H	05-08
0309H	03-09	0409H	04-09	0509H	05-09
030AH	03-10	040AH	04-10	050AH	05-10
030BH	03-11	040BH	04-11	050BH	05-11
030CH	03-12	040CH	04-12	050CH	05-12
030DH	03-13	040DH	04-13	050DH	05-13
030EH	03-14	040EH	04-14	050EH	05-14
030FH	03-15	040FH	04-15	050FH	05-15
0310H	03-16			0510H	05-16
0311H	03-17			0511H	05-17
0312H	03-18			0512H	05-18
0313H	03-19			0513H	05-19
				0514H	05-20
				0515H	05-21
				0516H	05-22
				0517H	05-23
				0518H	05-24
				0519H	05-25
				051AH	05-26
				051BH	05-27
				051CH	05-28
				051DH	05-29
				051EH	05-30
				051FH	05-31
				0520H	05-32

Register No.	Function	Register No.	Function	Register No.	Function
Group06		Group07		Group08	
0600H	06-00	0700H	07-00	0800H	08-00
0601H	06-01	0701H	07-01	0801H	08-01
0602H	06-02	0702H	07-02	0802H	08-02
0603H	06-03	0703H	07-03	0803H	08-03
0604H	06-04	0704H	07-04	0804H	08-04
0605H	06-05	0705H	07-05	0805H	08-05
0606H	06-06	0706H	07-06	0806H	08-06
0607H	06-07	0707H	07-07	0807H	08-07
0608H	06-08	0708H	07-08	0808H	08-08
0609H	06-09	0709H	07-09	0809H	08-09
060AH	06-10				
060BH	06-11				
060CH	06-12				
060DH	06-13				
060EH	06-14				
060FH	06-15				
0610H	06-16				
0611H	06-17				
0612H	06-18				
0613H	06-19				
0614H	06-20				
0615H	06-21				
0616H	06-22				
0617H	06-23				
0618H	06-24				
0619H	06-25				
061AH	06-26				
061BH	06-27				
061CH	06-28				
061DH	06-29				
061EH	06-30				
061FH	06-31				
0620H	06-32				
0621H	06-33				
0622H	06-34				
0623H	06-35				
0624H	06-36				

0625H	06-37				
0626H	06-38				
0627H	06-39				

Register No.	Function	Register No.	Function	Register No.	Function
Group09		Group10		Group11	
0900H	09-00	0A00H	10-00	0B00H	11-00
0901H	09-01	0A01H	10-01	0B01H	11-01
0902H	09-02	0A02H	10-02	0B02H	11-02
0903H	09-03	0A03H	10-03	0B03H	11-03
0904H	09-04	0A04H	10-04	0B04H	11-04
0905H	09-05	0A05H	10-05	0B05H	11-05
0906H	09-06	0A06H	10-06	0B06H	11-06
0907H	09-07	0A07H	10-07	0B07H	11-07
0908H	09-08	0A08H	10-08	0B08H	11-08
0909H	09-09	0A09H	10-09	0B09H	11-09
		0A0AH	10-10	0B0AH	11-10
		0A0BH	10-11	0B0BH	11-11
		0A0CH	10-12		
		0A0DH	10-13		
		0A0EH	10-14		
		0A0FH	10-15		
		0A10H	10-16		
		0A11H	10-17		
		0A12H	10-18		
		0A13H	10-19		
		0A14H	10-20		
		0A15H	10-21		
		0A16H	10-22		

Register No.	Function	Register No.	Function	Register No.	Function
Group12		Group13			
0C00H	12-00	0D00H	13-00		
0C01H	12-01	0D01H	13-01		
0C02H	12-02	0D02H	13-02		
0C03H	12-03	0D03H	13-03		
0C04H	12-04	0D04H	13-04		
0C05H	12-05	0D05H	13-05		
		0D06H	13-06		
		0D07H	13-07		
		0D08H	13-08		

Information
provided by
EMAG
Tel: 01902 601403
www.emag-ltd.co.uk

Appendix 4: JN5-CM-USB instruction manual

1. Model number and specification

1.1 Model number and function instruction

JN5-CM-USB is a RS232 USB type to RS485 converter. It is used for communication between PC and inverter.

1.2 Dimensions of JN5-CM-USB

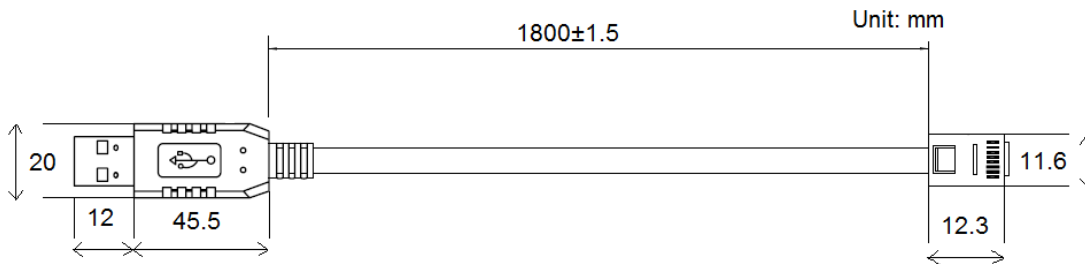

1.3 Connection between inverter and computer.

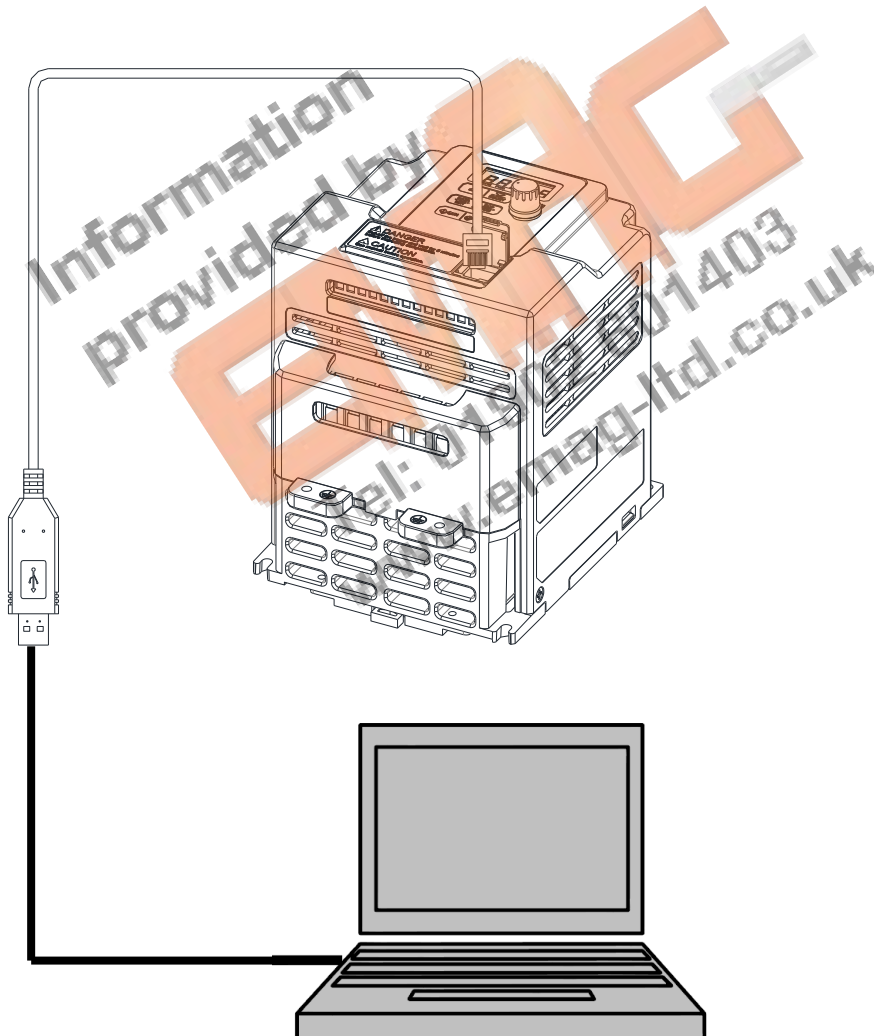

2. USB Interface Cable Pin Definition

2.1 RS232/USB at PC side.

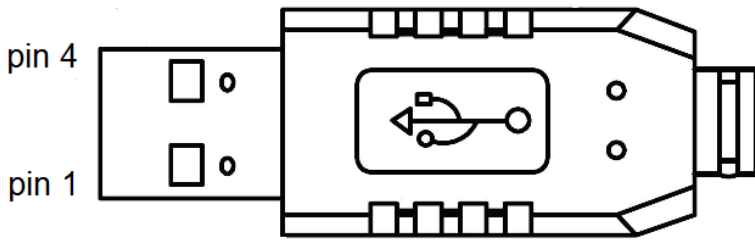

RS485/RJ45 connector at inverter side.

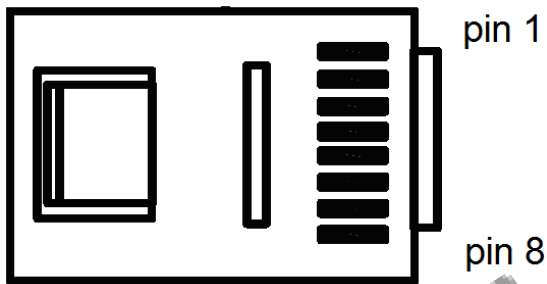

2.2 RS485/RJ45 Pin Definition.

Pin No.	Pin 1	Pin 2	Pin 3	Pin 4	Pin 5	Pin 6	Pin 7	Pin 8
Define	A	B	NC	NC	NC	NC	VCC	GND

Note:

1. A/B phase signal (Pin1&Pin2) is differential mode data signal of RS485.
2. VCC&GND is the +5Vdc power supply provided by inverter internal power source.



3. Notice



- 3-1. Please turn off the power before you connect the cable..
- 3-2. Once inverter is powered off during communication. PC software will show “communication error”.
- 3-3. If there is any error during communication, please check the wiring connection and restart the pc software.

Appendix 5: 510 series accessories manual

Accessories	Model	Function	Notes
Keypad Extension cable	JN5-CB-01M	Keypad extension cable for 510 series	1m
	JN5-CB-02M		2m
	JN5-CB-03M		3m
	JN5-CB-05M		5m
NEMA Kits	JN5-NK-E01	Mechanical device consisting of anti-dust cover on the upper part and wiring box on the bottom to meet NEMA 1	Only for frame1
	JN5-NK-E02		Only for frame2
	JN5-NK-E03		Only for frame3
	JN5-NK-E04		Only for frame4
Copy module	JN5-CU	<ul style="list-style-type: none"> ① Duplicating parameters setting from one inverter to another inverter ② As a remote keypad to be used ③ Using RJ45 line to connect inverter 	
Communication modules	JN5-CM-PDP	For connection of Profibus-DP communication protocol	For 510 series
	JN5-CM-TCP-IP	For connection of TCP-IP communication protocol	
	JN5-CM-DNET	For connection of DeviceNet communication protocol	
	JN5-CM-CAN	For connection of CANopen communication protocol	
RJ45 to USB connection cable	JN5-CM-USB	Using the TECO exclusive PC-software line	1.8m
	JN6-CM-USB-3		3m

Préface

- ◆ Le produit est un lecteur conçu pour commander un moteur à induction triphasé. lisez attentivement ce manuel pour garantir le bon fonctionnement, la sécurité et pour se familiariser avec les fonctions d'entraînement.
- ◆ Le lecteur est un appareil électrique / électronique et doit être installé et géré par un personnel qualifié
- ◆ Une mauvaise manipulation peut entraîner un fonctionnement incorrect, cycle de vie plus court, ou l'échec de ce produit ainsi que le moteur.
- ◆ Tous les documents sont sujets à changement sans préavis. Soyez sûr d'obtenir les dernières éditions de l'utilisation ou visitez notre site Web
- ◆ Lire le manuel d'instructions avant de procéder à l'installation, les connexions (câblage), le fonctionnement ou l'entretien et l'inspection.
- ◆ Vérifiez que vous avez une bonne connaissance de l'entraînement et de vous familiariser avec les consignes de sécurité et les précautions avant de procéder à fonctionner le lecteur.
- ◆ prêtez attention aux consignes de sécurité indiquées par l'avertissement  et symbole Attention .

 Avertissement	ignorer les informations indiquées par le symbole d'avertissement peut entraîner la mort ou des blessures graves.
 Attention	ignorer les informations indiquées par le symbole de mise en garde peut entraîner des blessures mineures ou modérées et / ou des dommages matériels importants.

Chapitre 1 Consignes de sécurité

1.1 avant d'alimenter le disque dur

 Avertissement
<ul style="list-style-type: none">➤ Le circuit principal doit être correctement câblée. Pour les terminaux monophasés d'approvisionnement de l'utilisation des intrants (R/L1, T/L3) et de trois bornes d'entrée de l'utilisation de l'offre de phase (R/L1, S/L2, T/L3). U/T1, V/T2, W/T3 ne doivent être utilisés pour connecter le moteur. Raccordement de l'alimentation d'entrée à l'un des U/T1, V/T2 W/T3 ou bornes risque d'endommager le lecteur.

 Attention
<ul style="list-style-type: none">➤ Pour éviter que le couvercle ne se désengage ou de tout autre dommage physique, ne portez pas le lecteur par son couverture. Soutenir le groupe par son dissipateur de chaleur lors du transport. Une mauvaise manipulation peut endommager le lecteur ou blesser le personnel, et doit être évitée.➤ Pour éviter que les risques d'incendie, ne pas installer le lecteur sur ou à proximité d'objets inflammables. Installer sur des objets ininflammables comme les surfaces

métalliques.

- Si plusieurs disques sont placés dans le même panneau de contrôle, fournir une ventilation adéquate pour maintenir la température en dessous de 40 ° C/104 ° F (50 ° C/122 ° F sans housse de protection) pour éviter la surchauffe ou incendie.
- Lors d'un retrait ou d'installation de l'opérateur numérique, éteignez-le d'abord, puis de suivre les instructions de ce manuel pour éviter les erreurs de l'opérateur ou de la perte de l'affichage causé par des connexions défectueuses.



Avertissement

- Lors d'un retrait ou d'installation de l'opérateur numérique, éteignez-le d'abord, puis de suivre les instructions de ce manuel pour éviter les erreurs de l'opérateur ou de la perte de l'affichage causé par des connexions défectueuses....

1.2 Câblage



Avertissement

- Coupez toujours l'alimentation électrique avant de procéder à l'installation d'entraînement et le câblage des terminaux utilisateurs.
- Le câblage doit être effectué par un personnel qualifié / électricien certifié.
- Assurez-vous que le lecteur est correctement mis à la terre. (220V Classe: impédance de mise à la terre doit être inférieure à 100Ω Classe 440V: Impédance de mise à la terre doit être inférieure à 10Ω.)
- vérifier et tester mes circuits d'arrêt d'urgence après le câblage. (L'Installateur est responsable du câblage.)
- Ne touchez jamais de l'entrée ou de lignes électriques de sortie permettant directement ou toute entrée ou de lignes de puissance de sortie à venir en contact avec le boîtier d'entraînement.
- Ne pas effectuer un test de tenue en tension diélectrique (mégohmmètre) sur le disque dur ou cela va entraîner des dommages de lecture pour les composants semi-conducteurs.



Attention

- La tension d'alimentation appliquée doit se conformer à la tension d'entrée spécifiée par le lecteur. (Voir la section signalétique du produit)
- Raccorder la résistance de freinage et de l'unité de freinage sur les bornes assignées.
- Ne pas brancher une résistance de freinage directement sur les bornes CC P (+) et N (-), sinon risque d'incendie.
- Utilisez des recommandations de la jauge de fil et les spécifications de couple. (Voir Wire Gauge et la section de spécification de couple) ◦
- Ne jamais brancher l'alimentation d'entrée aux bornes onduleur de sortie U/T1, V/T2, W/T3.
- Ne pas brancher un contacteur ou interrupteur en série avec le variateur et le moteur.
- Ne branchez pas un facteur condensateur de correction de puissance ou suppresseur de tension à la sortie du variateur ◦
- S'assurer que l'interférence générée par l'entraînement et le moteur n'a pas d'incidence sur les périphériques.

1.3 Avant l'opération



Avertissement

- Assurez-vous que la capacité du disque correspond aux paramètres de notation avant d'alimenter.
- Réduire le paramètre de la fréquence porteuse si le câble du variateur au moteur est supérieure à 80 pi (25 m). Un courant de haute fréquence peut être générée par la capacité parasite entre les câbles et entraîner un déclenchement de surintensité du variateur, une augmentation du courant ou d'une lecture actuelle inexacts.
- Veillez à installer tous les couvercles avant de l'allumer. Ne retirez pas les capots pendant que l'alimentation du lecteur est allumé, un choc électrique peut se produire autrement.
- Ne pas actionner d'interrupteurs avec les mains mouillées, un choc électrique pourrait survenir autrement.
- Ne touchez pas les bornes d'entraînement lorsqu'il est alimenté, même si le lecteur est arrêté, un choc électrique pourrait survenir autrement.

1.4 Configuration Paramètre



Attention

- Ne branchez pas une charge pour le moteur tout en effectuant un auto-tune.
- Assurez-vous que le moteur peut fonctionner librement et il y a suffisamment d'espace autour du moteur lors de l'exécution d'un auto-tune rotation.

1.5 Opération



Avertissement

- Veillez à installer tous les couvercles avant de l'allumer. Ne retirez pas les capots pendant que l'alimentation du lecteur est allumé, un choc électrique peut se produire autrement.
- Ne pas brancher ou débrancher le moteur pendant le fonctionnement. Le variateur pourrai se déclencher et ainsi endommager le lecteur.
- Les opérations peuvent commencer soudainement si une alarme ou un défaut est réarmé avec un ordre de marche active. Assurez-vous qu'un ordre de marche est actif lors de la réinitialisation de l'alarme ou de défaut, autrement des accidents peuvent se produire.
- Ne pas actionner d'interrupteurs avec les mains mouillées, un choc électrique pourrait survenir .
- Un interrupteur d'urgence externe indépendant est fourni, qui s'arrête en urgence vers le bas la sortie de l'onduleur en cas de danger.
- Si le redémarrage automatique après une récupération d'énergie est activée, le variateur démarrera automatiquement après le rétablissement du courant.
- Assurez-vous qu'il est sûr de faire fonctionner le variateur et le moteur avant d'effectuer un auto-tune rotation.
- Ne touchez pas les bornes d'entraînement lorsqu'il est alimenté même si l'onduleur s'est arrêté, un choc électrique pourrait survenir .
- Ne pas contrôler les signaux sur les circuits pendant que le lecteur est en marche.
- Après la mise hors tension, le ventilateur de refroidissement peut continuer à fonctionner pendant un certain temps.



Attention

- Ne touchez pas les composants générant de la chaleur tels que radiateurs et des résistances de freinage.
- Vérifiez soigneusement la performance du moteur ou de la machine avant d'utiliser à grande vitesse, sous peine de blessure.
- Notez les réglages des paramètres liés à l'unité de freinage lorsque applicable.
- Ne pas utiliser la fonction de freinage d'entraînement pour un maintien mécanique, sous peine de blessure.
- Ne pas contrôler les signaux sur les circuits pendant que le lecteur est en marche.

1.6 Entretien, Inspection et remplacement



Avertissement

- Attendre un minimum de 5 minutes après que l'alimentation a été débranchée avant de commencer une inspection. Vérifiez également que le voyant de charge est éteint et que la tension du bus cc a chuté au-dessous de 25Vdc.
- Ne jamais toucher les bornes à haute tension dans le lecteur.
- Assurez-vous que l'alimentation du lecteur est débranché avant de démonter le lecteur.
- Seul le personnel autorisé peuvent faire l'entretien, l'inspection et les opérations de remplacement. (Enlevez les bijoux en métal tels que les montres et les bagues et utiliser des outils isolés.)



Attention

- Le variateur peut être utilisé dans un environnement avec une gamme de température allant de 14 ° -104 ° F (10-40 ° C) et l'humidité relative de 95% sans condensation.
- Le variateur doit être utilisé dans un environnement sans poussière, gaz, vapeur et humidité.

1.7 Mise au rebut du variateur



Attention

- jeter cet appareil avec soin comme un déchet industriel et selon les réglementations locales nécessaires.
- Les condensateurs du circuit principal d'entraînement et circuits imprimés sont considérés comme des déchets dangereux et ne doivent pas être brûlés.
- The Plastic enclosure and parts of the drive such as the top cover board will release harmful gases if burned.

Motor over temperature protection is not provided.